

Keep This Manual Handy For Quick Reference

OWNER'S MANUAL

For SUPERMAX 25 and SUPERMAX 37 (Single Drum);
SUPERMAX 25x2 and SUPERMAX 37x2 (Dual Drum)



SHOWN WITH OPTIONAL CASTERS, 25"

IMPORTANT: BEFORE OPERATING YOUR SUPERMAX, READ THE INSTRUCTIONS IN THIS MANUAL FOR UNPACKING AND SETTING UP YOUR MACHINE.



SuperMax
Tools

2 SUPERMAX OWNER'S MANUAL

CONGRATULATIONS

You have made a wise purchasing decision by adding this "Made In USA" machine to your tool line-up. The main purpose in inventing and developing the machine you've purchased was to bring a new dimension of productivity to your workshop, be it large or small. Right from the start, our goal at SuperMax Tools has been to manufacture equipment that is capable of providing you with maximum economy, maximum utility, and maximum performance.

Your SuperMax Tools drum sander will pay you back many fold in the years ahead by helping you get better results in less time, start to finish. This tool incorporates a bundle of exclusive features which you will appreciate more every time you use it. All SuperMax Tools drum sanders feature patented self-cooling drums and spring-tension abrasive take-up fasteners, as well as sealed and permanently lubricated bearings. The exclusive SuperMax Tools variable-speed power feed conveyor system provides you with ultra-precise control, whether you are surfacing rough-sawn lumber, dimensioning otherwise unusable stock, cleaning up glued panels, or finish sanding either thick stock or the thinnest veneers.

SuperMax Tools and its dealers are committed to providing you with innovative solutions, from selecting the right machine to helping you get top performance when you put it to work in your shop. Regardless of how you take advantage of these innovations, we are confident our equipment will help bring you a giant step forward in precision shop productivity.

CAUTION, SAFETY FIRST

When maintaining and operating this machine, always put safety first. For your own safety, read and understand this owner's manual before operating this machine. Always heed and follow all normal safety precautions, including the following:

- **Always wear eye protection while operating the sander.**
- **Always feed stock against the drum rotation.**
- **Never place hands or fingers under the drum or dust cover.**
- **Keep hands and clothing away from operating drums.**
- **Never operate the sander without its dust cover or drum and belt guarding in place.**
- **Always maintain control of boards to avoid kickback; know how to prevent it.**
- **Always disconnect electrical power before doing any servicing or adjusting of the machine.**

MODEL IDENTIFICATION

Your SUPERMAX drum sander is one of a family of machines from SuperMax Tools designed to help you achieve results comparable to industrial-size sanders at a fraction of the cost. The SUPERMAX is available in 25" or 37" sizes in single drum or dual drum models. For future reference, attach the Model/Serial # Bar Code label below or find the model and serial numbers on the front table mount (#20, page 39) and write them in below.

Model: _____

Serial Number: _____

Date Purchased: _____

Dealer: _____

IMPORTANT: KEEP THIS MANUAL HANDY

Please read this manual first. It was designed to help you get the most from your SUPERMAX drum sander. Before unpacking or using the machine, familiarize yourself with its components, features, and basic adjustments by reviewing the following

pages. You will find it an invaluable aid in setting up, operating and servicing your machine. If, after reviewing this manual, you still have a problem you can't solve, please call your SuperMax Tools dealer.

CONTENTS

ABOUT THE SUPERMAX SYSTEM

SUPERMAX Nomenclature4
 Unpacking Your SUPERMAX Sander5

SETTING UP YOUR SUPERMAX

Making Electrical Connections6
 Connecting Dust Collectors7
 Checking For Machine Level7
 Checking Drum Alignment7
 Checking The Conveyor Belt8
 Checking Table Height Controls9
 Monthly Maintenance9
 Wrapping Abrasive Strips10

OPERATING YOUR SUPERMAX

Basic Operating Procedures12
 SUPERMAX Operating Controls12
 Setting The Depth of Cut13
 Setting Single or Primary Drum13
 Setting Secondary Drum
 (Dual Drum Machines)13
 Disengaging The Drums
 (Dual Drum Machines)14
 Selecting Intellisand™ Feed Rates14
 Using The Depth Gauge15
 Selecting Drum Abrasives16
 Tips For Maximum Performance17

TROUBLESHOOTING YOUR SUPERMAX

Troubleshooting Guide: Motors19
 Troubleshooting Guide: Machine20
 Troubleshooting Guide: Operations22

SERVICING YOUR SUPERMAX

Adjusting Height Controls24
 Adjusting Table Support Castings25
 Adjusting Sanding Drums26
 Adjusting Tension Rollers28
 Replacing Sanding Drums29
 Replacing Conveyor Belts31
 Replacing V-Belt32
 Rotating/Replacing Drum Bearings33
 Replacing Electrical Components36
 Electrical Diagram36

SUPERMAX TECHNICAL DATA

SUPERMAX Specifications37
 Parts List For SUPERMAX Stand38
 Parts List For Single Drum Assembly40
 Parts List For Dual Drum Assembly42
 Parts List For Conveyor Assembly44
 SUPERMAX Accessories & Supplies47

FOR YOUR SAFETY: Read all instructions carefully, and note the safety cautions on the opposite page and on the back cover of this manual.

ABOUT THE SUPERMAX SYSTEM

This manual is designed to help you become familiar with your SUPERMAX drum sander, and to help you take advantage of its exclusive features. By understanding its major components, and how they work together, you will be able to get the most from your investment. The SUPERMAX system is basically made up of the following five major

components: 1) precision machined revolving drums wrapped with abrasive strips held by a 2) patented take-up mechanism to process stock fed by the 3) no-give conveyor table which is adjusted by 4) an infinitely variable power feed motor and a 5) convenient height adjustment mechanism. The illustration below shows the major components.

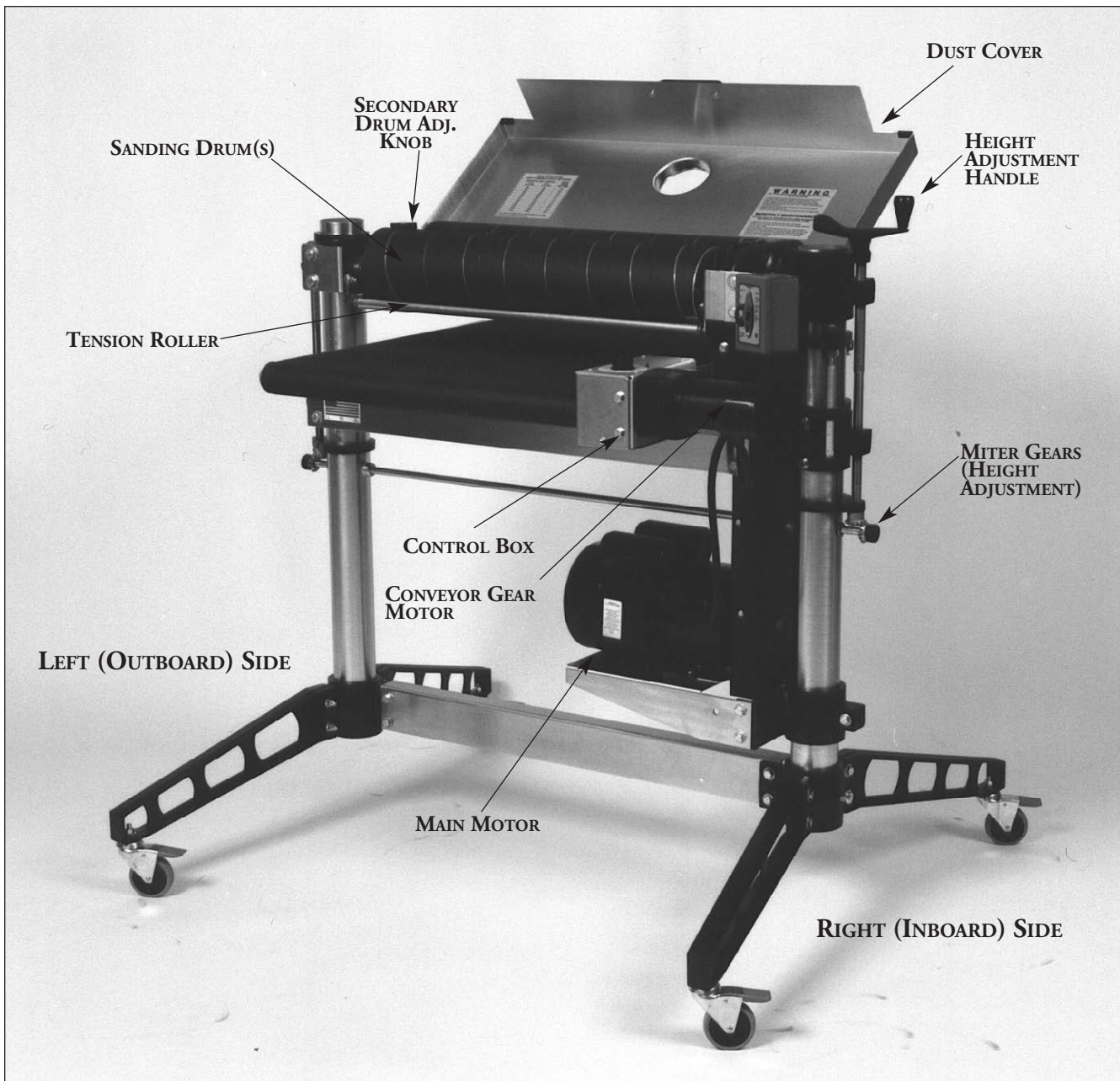

Fig. 1. SUPERMAX nomenclature.

UNPACKING YOUR SUPERMAX

Your SUPERMAX sander has been shipped completely assembled from the factory in a cardboard shroud on a pallet and shrink-wrapped in plastic. If any damage has occurred as a result of shipment, notify the transportation company as soon as possible and ask them to make an immediate inspection. Ask for a damage or loss report. Also notify your dealer of any loss or damage during shipment. See enclosed Warranty Statement.

Important: To avoid problems and potential damage to the machine, please read through the unpacking instructions below before proceeding to set up the machine in your shop.

1. Unbolt the machine legs from the shipping pallet. Install the rubber-based leveling feet or casters on legs (Fig. 2). The feet and mounting hardware are in the STOP bag packed with your machine.

2. Loosen the hex nut and set screws on the table support castings (Fig. 3). The set screws on the table support castings have been tightened at the factory to eliminate free-play between the table support casting and the column tube during shipment. There are two table support castings on the SUPERMAX, one each for the right and left column tubes. Important: These set screws are tightened for shipping and must be loosened and readjusted before operating either the height adjustment mechanism or the conveyor drive.

To properly adjust for operation, loosen each set screw by first loosening its hex nut with an open-end wrench and then the set screw with an Allen wrench. Then retighten each set screw with your fingers so it only lightly touches the column tube.

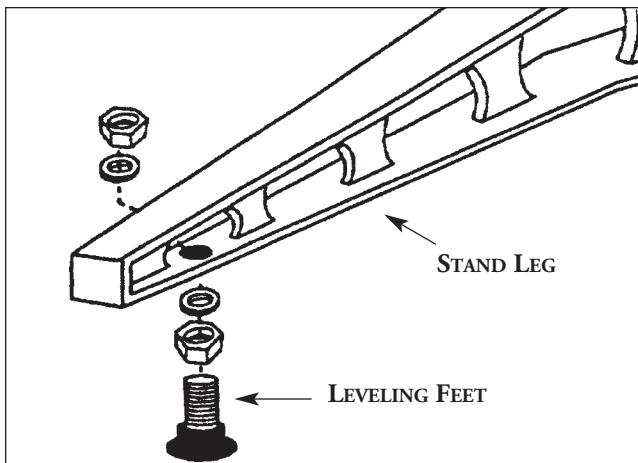

Fig. 2. Leveling feet and mounting hardware.

Hold each set screw in position with an Allen wrench and retighten the hex nut. Failure to follow these procedures may result in misalignment of the drum(s) and/or the conveyor table.

Caution: On the SUPERMAX models do not loosen the set screws on the upper drum support castings.

3. Install the power feed gear motor. Rotate the drive roller on the conveyor system so the flat part of the shaft is down. If necessary, plug the gear motor into an appropriate 220V AC outlet to rotate the motor output shaft coupling so the set screws face downward. Unplug the gear motor. Slide the power feed motor assembly onto the drive roller shaft, aligning the shaft coupling and four mounting holes. Start the four 5/16" hex head bolts on the power feed motor mounting bracket, but do not tighten yet.

Next, tighten the set screws in the coupling on the drive roller shaft, making sure they are on the flat of the shaft. Rock the drive roller while tightening the set screws to make sure they are centered properly on the flat. Install the safety shield on the bottom of the assembly with two screws. Then plug in the cord and turn conveyor on full speed. While it is running, tighten the four 5/16" bolts to secure the motor assembly in place.

4. If necessary, adjust the tension of the V-belt between the primary motor and driven pulleys. To do this, loosen the two screws in lower belt guard and loosen the pinch bolt located at the back of the motor support casting. Slide the motor support casting down the column tube until the V-belt is taut. Tighten the two screws in lower belt guard. Retighten the motor support pinch bolt.

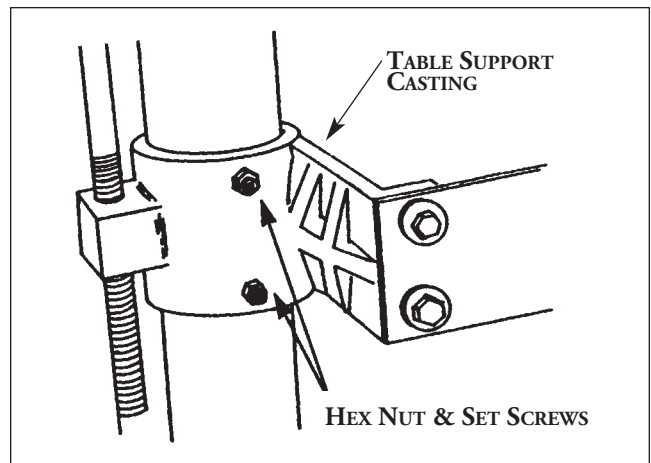

Fig. 3. Table support casting and set screws.

SETTING UP YOUR SUPERMAX

Your SUPERMAX drum sander was adjusted and aligned at the factory, and it has been carefully packed for shipment. However, because of possible stress during transit, the unit should be thoroughly checked before being put to use. This section covers the pre-operational checks you should make after unpacking and final assembly. Unnecessary problems can be avoided if these essential checks are performed before operating the sander. Likewise, performing the recommended monthly maintenance procedures listed at the end of this section will help assure trouble-free service.

MAKING ELECTRICAL CONNECTIONS

The neutral wire (white) in the power cord to the sander is not used and does not need to be connected on four wire 220V single phase (angle connector) or five wire 220V three phase power connections. Please see wiring diagrams on pages 36 and 37 for details.

Single Phase: The drum(s) of all SUPERMAX single phase sanders are powered by a 5 HP, 208-230 volt, single phase motor. A NEMA 14-30 plug and cord is supplied. Included with the sander is a NEMA 14-30 flush mount receptacle to use with the sander. Single phase SUPERMAX sanders require a minimum dedicated circuit of

10-gauge wire protected by a 30-amp fuse or breaker. Extension cords are not recommended, but if used, should be of at least 10-gauge wire for lengths up to 10' and of at least 8-gauge wire for longer lengths.

Three Phase: The drums of SUPERMAX three phase sanders are powered by a 5 hp, 208-230 volt, three phase motor. Three phase machines include a five wire cord but no plug. Three phase SUPERMAX sanders require a minimum dedicated 20-amp circuit. Extension cords are not recommended,



Fig. 4. Thermal-overload switch, on some models.

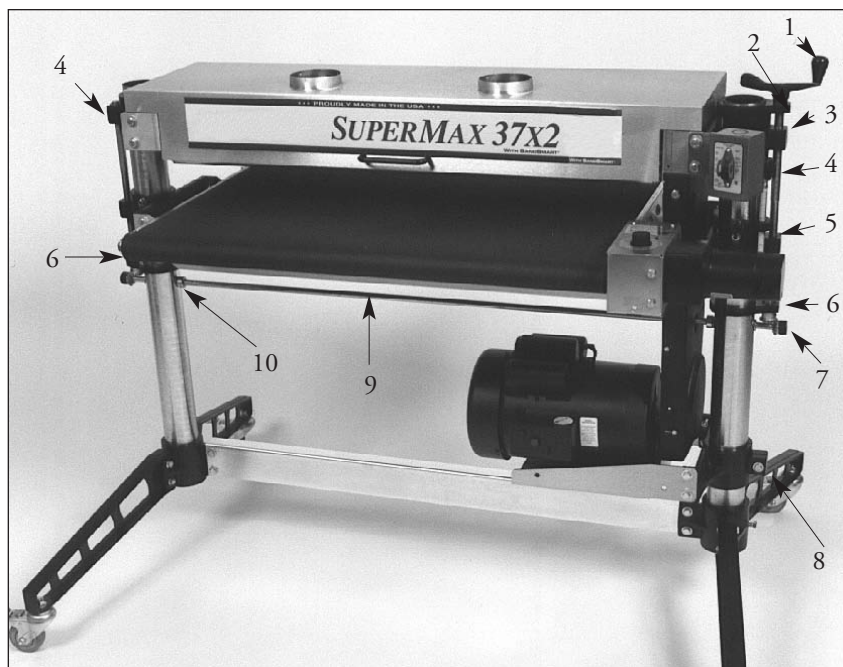

Fig. 5. SUPERMAX Components.

1. Height Adjustment Handle.
2. Adjusting Screw Support.
3. Drum Support Casting.
4. Height Adjusting Screw.
5. Table Support Casting.
6. Adjusting Screw Support.
7. Miter Gear.
8. Motor Support Casting.
9. Transfer Rod.
10. Shaft Collars.

but if used, should be 12-gauge wire for lengths up to 10' and 10-gauge wire for longer lengths.

Note: The Intellisand™ Control (Fig. 6) protects both motors from most overload situations. The conveyor motor for feeding stock is infinitely variable from 0-15 ft/min. If the load on the drum motor reaches its optimum, the SandSmart Control will automatically slow the feed rate of the conveyor. When the load is decreased on the main motor, the feed rate will automatically increase but never exceed the manual setting on the dial.

CONNECTING DUST COLLECTORS

Dust collection is necessary for all SUPERMAX models. The SUPERMAX 25" models are equipped with one 4"-diameter dust exhaust port at the top of the drum cover. The SUPERMAX 37" models have two 4" dust exhaust ports.

To attach the SUPERMAX to your collection system, install 4" hose from your collector. (See Tips For Maximum Performance, page 17 of this manual.) The **minimum** recommended dust collector capacities at the dust port(s) are: SUPERMAX 25 and SUPERMAX 25x2: 600 CFM; SUPERMAX 37 and SUPERMAX 37x2: 1,200 CFM. For best results, follow the recommendations of the manufacturer of your dust collection equipment.

CHECKING MACHINE FOR LEVEL

Proper leveling of the machine is essential to achieve continued maximum performance from the SUPERMAX. Before making fine adjustments, place the unit where it will be used in the shop. Then adjust the four leveling feet using a carpenter's level both across the machine and in line with the machine, placing the level on the conveyor bed. If you have equipped your SUPERMAX with the caster set, do the same after positioning the machine where it will be operated most often. Mark the position of the legs on the floor with tape so it can be returned to the same position.

CHECKING DRUM ALIGNMENT

Your SUPERMAX was shipped from the factory preadjusted with the drum(s) aligned to the conveyor table. Unless the machine was stressed during shipment, only fine adjustment should be necessary. Minor alignment corrections can be done without relieving V-belt tension or adjusting the tension rollers, but should be done without any abrasive strips attached.

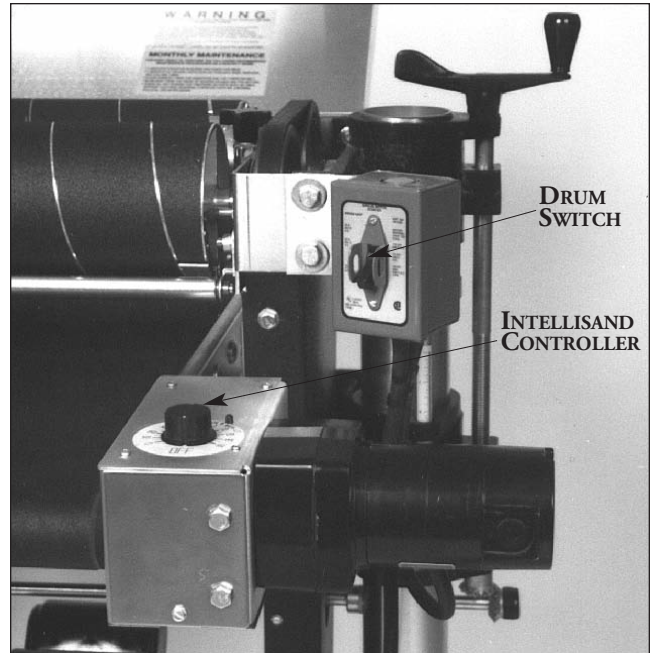

Fig. 6. Intellisand Controller.

Using a flat piece of wood or metal as a thickness gauge, insert it between the conveyor table and the primary (front) drum on the left (outboard) side of the machine (see Fig. 26). Raise the table up so the drum just contacts the thickness gauge. Then, holding up the front tension roller, check at outboard side (Fig. 7) of the drum to see that the drum is parallel to the table. If it is not, disengage



Fig. 7. Checking drum alignment (inboard side).

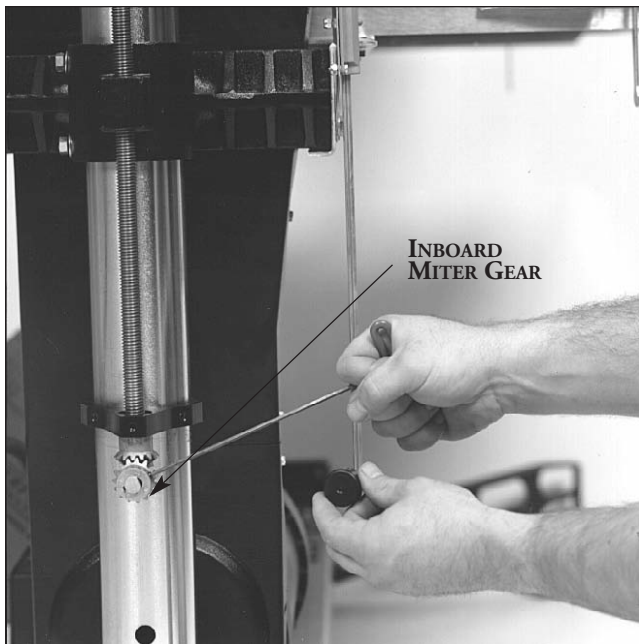

Fig. 8. Adjusting primary drum alignment.

the right (inboard) miter gear (see Fig. 8), finely raise or lower the right (inboard) side of the table to achieve parallel alignment of the front (primary) drum. The distance between the conveyor table and both sides of the front drum should be the same. Reinstall the miter gear, aligning the set screw to the flat of the shaft.

Dual Drum Models: Before altering this conveyor table position, also check to see that the rear drum (dual drum models only) is likewise parallel to the conveyor table, with both sides at the same height above the table. Using the same thickness gauge, check both sides of the rear drum from the rear of the machine while holding up the rear tension roller. Adjustment of the rear drum is done by using the right and left drum adjustment knobs (see Fig. 9).

After the rear drum is adjusted, it is important to reset the rear drum adjustment indicators to zero on both sides. Set the secondary drum adjustment indicators by loosening hex nut, then moving the indicator scale so that the zero mark is directly under the needle, and retightening the hex nut (see Fig. 9). Likewise, zero the indicator for other side of drum. Take care not to overtighten the hex nut of the indicator. This can flare the brass bushing and render the indicator inoperable.

Also check that the secondary drum adjustment knobs turn with a slight resistance to avoid any

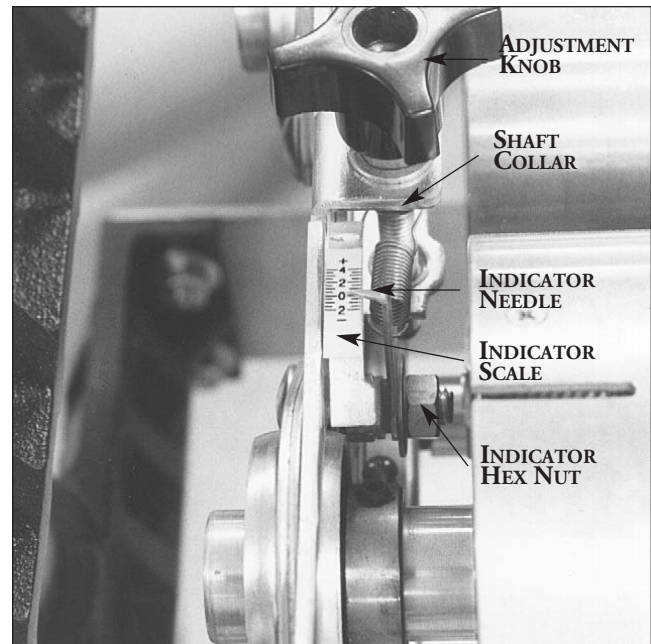

Fig. 9. Rear drum adjustment indicator.

movement during operation. To adjust knob resistance, turn the knob clockwise to reveal the set screw on the shaft collar below the bracket, then loosen the screw. Making sure the adjustment knob is tightly seated on top of the bracket, raise the shaft collar up against the bracket from below and retighten the set screw. **Note: The nut of the rear bolt on the rear (secondary) drum bearing bracket should be backed off a quarter-turn from being fully tightened. This allows the lock washer to be depressed slightly but not completely. This is the pivot point for the rear drum.**

CHECKING THE CONVEYOR BELT

Conveyor belt tension and tracking adjustments may occasionally be necessary during break-in and normal operation to compensate for belt stretching. Install Ceramic Guides at this time. See the Ceramic Guides instruction sheet inside Ceramic Guides box, for details. Ceramic Guides are packaged separate on sander.

Belt Tension. To adjust the tension of the conveyor belt, first adjust the take-up screw nut (see Fig. 10) on both sides of the conveyor to obtain approximately equal tension on both sides of the belt when taut. Insufficient belt tension will cause slippage of conveyor belt on the drive roller during sanding operation. The conveyor belt is too loose if it can be stopped by hand pressure applied directly to the top of the conveyor belt. Excessive belt tension can

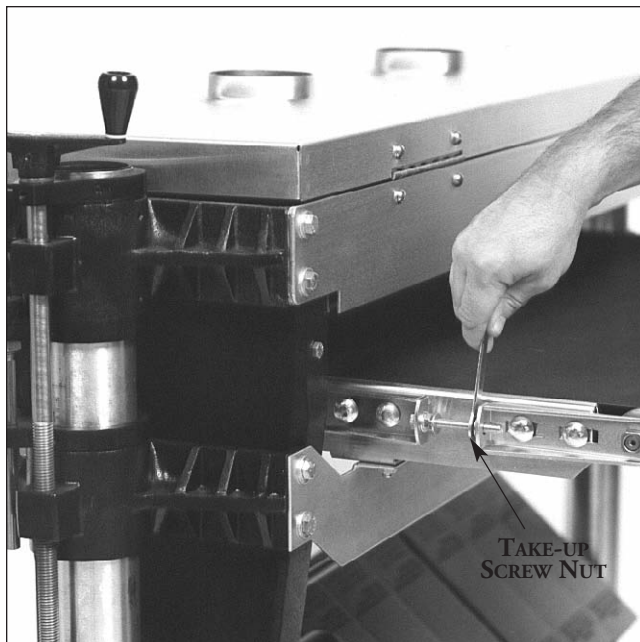

Fig. 10. Adjusting conveyor belt tracking.

result in bent rollers, premature wearing of the bronze bushings or belt.

Belt Tracking. Belt tracking adjustments are made while the conveyor belt is running. After the proper belt tension is obtained (see above), turn the conveyor unit on and set it at the fastest speed setting. Watch for a tendency of the conveyor belt to drift to one side of the conveyor. To adjust the belt tracking, tighten the take-up screw nut (see Fig. 10) on the side the belt is drifting toward, and loosen the take-up screw nut on the opposite side. Adjusting the take-up screw nuts on either side of the conveyor allows belt tracking adjustments to be made without affecting belt tension. **NOTE:** Adjust the take-up screw nuts only 1/4 turn at a time. Then allow time for the belt to react to the adjustments before proceeding further. Try to avoid over-adjustments. Make sure wrench is below surface when sanding.

CHECKING TABLE HEIGHT CONTROLS

The table height and depth of cut is controlled by the height adjustment handle (see Fig. 11). Turning the handle raises or lowers both sides of the table simultaneously by transferring the handle rotation through the miter gear and cross bar assembly.

Important: Before using the height adjustment, be sure to loosen both the set screws located on the front of both table support castings (see Fig. 3 and Fig. 11) to allow the table support to slide on both column tubes. These set screws are tightened for shipping and must be loosened and readjusted to

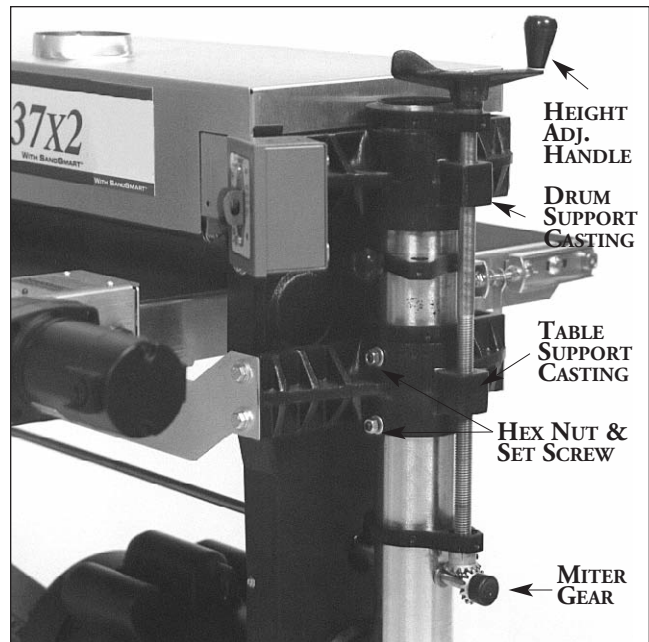

Fig. 11. Table height adjustment mechanism.

allow the table support castings to move freely on the column support tubes. Readjust the set screws just so they eliminate free-play between the table support casting and the column tube. To properly adjust, tighten the set screws (see Fig. 3) only finger-tight so they lightly touch the column tubes. Then hold each set screw in position with an Allen wrench and tighten the hex nut.

Check the operation of the height adjustment mechanism. If it does not operate smoothly or easily, further adjustments may be necessary. Refer to the servicing section of this manual, which begins on page 24, for further adjustment procedures.

MONTHLY MAINTENANCE

For best results, perform the following recommended maintenance procedures on a monthly basis:

- Lubricate conveyor bushings and check for wear.
- Lubricate all moving parts, such as threaded rods, washers, and column tubes.
- Clean sawdust from the sandpaper and the conveyor belt.
- Blow dust from the inside of sanding drum(s) and the motors.
- Check all set screws for tightness on parts such as table support castings, bearings, conveyor coupler, castings, pulleys, and miter gears.

WRAPPING ABRASIVE STRIPS

Note: When using Pre-Marked™ OR Pre-Cut™ abrasives, not all of the steps below are necessary.

Proper attachment of the abrasive strip to the drum is critical to achieving top performance from your SuperMax Tools drum sander. Abrasive strips do not have to be pre-measured. The end of the roll is first tapered and attached to the left (outboard) side of the drum. Then the strip is wrapped around the drum, and the second taper is made for attachment to the right (inboard) side of the drum. To attach a strip to the drum, follow the procedure below.

1. Mark and cut a taper at one end of the roll as shown in Fig. 12a. Because the tapered end should use most of the left (outboard) slot width, its end must be trimmed (Fig. 12-b and 12-c). Raise the clip lever on the left (outboard) side of the drum (Fig. 12-d). Insert the tapered end through the slot and into the fastener so that it uses most of the width of the slot. Release the clip lever to securely hold the strip end in the fastener.

2. Wrap the strip around the drum, being careful not to overlap the windings. The tapered cut of the strip end should follow the edge of the drum. Continue to wrap the abrasive in a spiral fashion by rotating the drum with your left hand and guiding the strip with your right hand (Fig 12-e). Successive windings of the strip should be flush with previous windings without any overlap.

3. Mark the trailing end of the strip where it crosses the right (inboard) end of the drum (Fig. 12-f). From this point, cut a taper as was done with the starting edge of the strip. (The taper on the remaining roll can be used as the taper for the starting edge of the next strip to be cut.)

4. With the trailing edge of the strip properly cut, rewrap the drum and insert the tapered end through the slot in the right (inboard) end of the drum. Insert the tapered end into the inboard take-up fastener. Pull up on the clip lever to open the clip, and pull the take-up lever to the top as shown (Fig. 12-g). After inserting the strip end, release the clip lever by moving your index finger toward the drum slot. This allows the clip to retain the abrasive while holding the take-up lever in an “up” position.

5. The take-up fastener is designed to automatically take up any slack caused by stretching of the abrasive strip. **Important: Position the abrasive strip in the slot with sufficient room between the inside of the slot and the tapered end of the strip to allow it to be pulled into the drum as needed (Fig. 12-h).** Note that not leaving enough space between the strip and the inside of the slot will prevent the take-up fastener from operating properly.

6. The abrasive strip may stretch enough in use to allow the take-up lever to reach its lowest position so it no longer is able to maintain tension on the strip (Fig. 12-i). If this occurs, it will be necessary to reset the take-up lever by raising it, pushing the strip end into the slot, and then releasing the clip lever.

Note: A sandpaper cleaning stick may be used to remove deposits and help extend sandpaper life. To use, operate the sanding drum with the dust cover open. (Caution: For your own safety, always wear eye protection while performing sandpaper cleaning, and take all precautions to avoid any contact of hands or clothing with uncovered drums.) Hold the cleaning stick against the rotating drum and move it along the drum surface. It is good procedure to use a shop brush to remove any cleaning stick crumbs from the drums before resuming sanding opera-

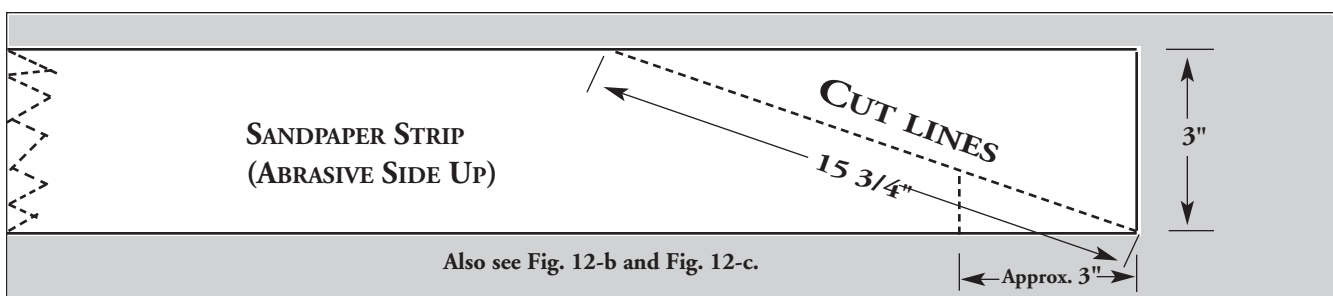

Fig. 12-a. Marking and cutting taper on strip.

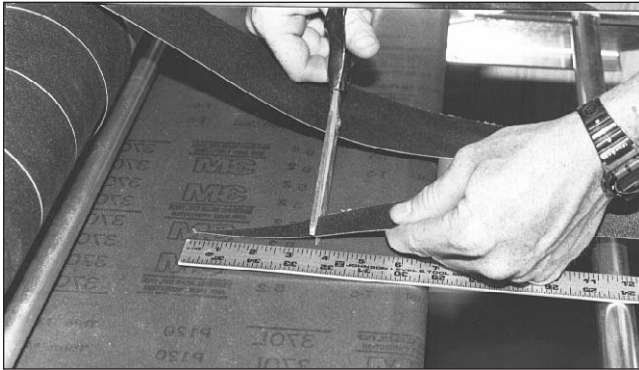

Fig. 12-b. Trim about 3" from end of cut taper.

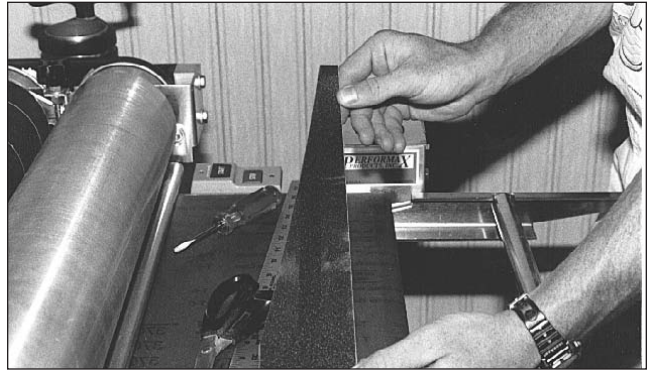

Fig. 12-c. Trimmed tapered end ready to install.

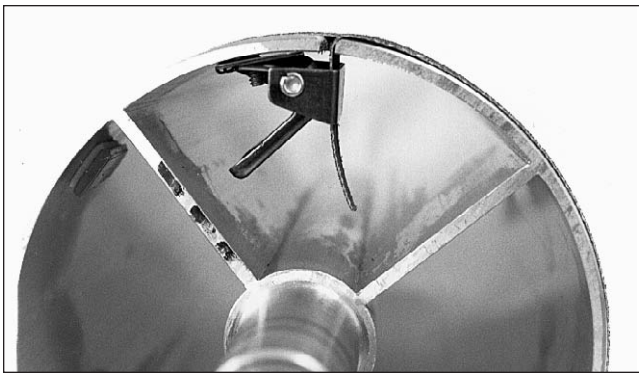

Fig. 12-d. Insert tapered end into outboard slot.

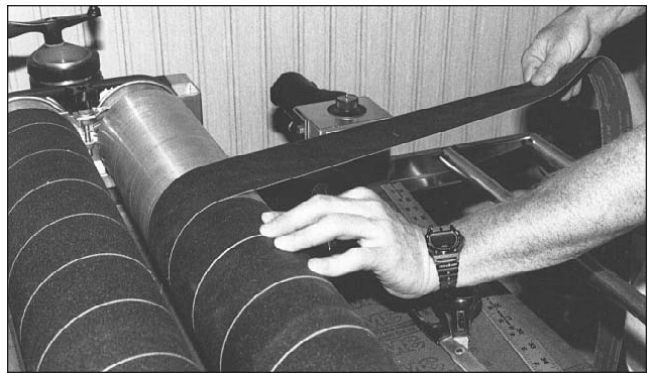

Fig. 12-e. Wrap strip around drum without overlap.

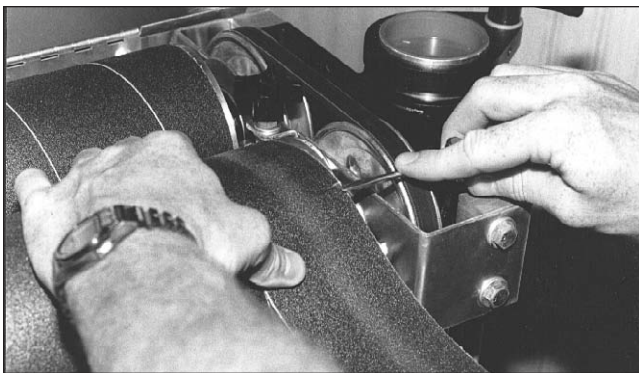

Fig. 12-f. Mark strip where it crosses drum edge.

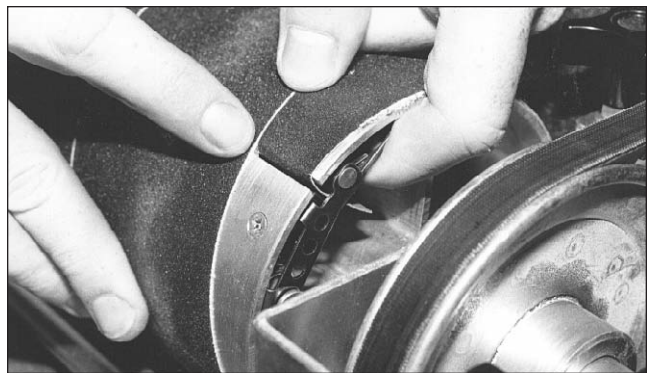

Fig. 12-g. Insert tapered end into inboard slot.

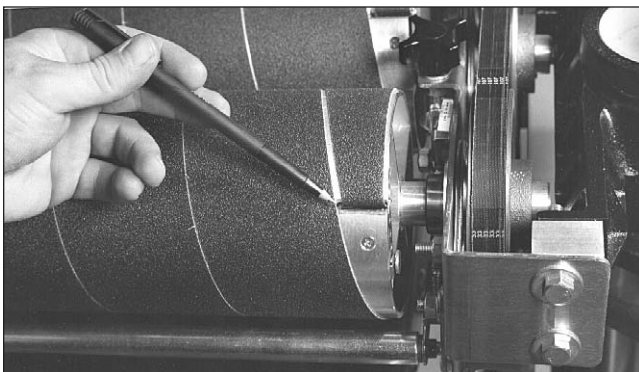

Fig. 12-h. Allow room inside slot for strip to move.

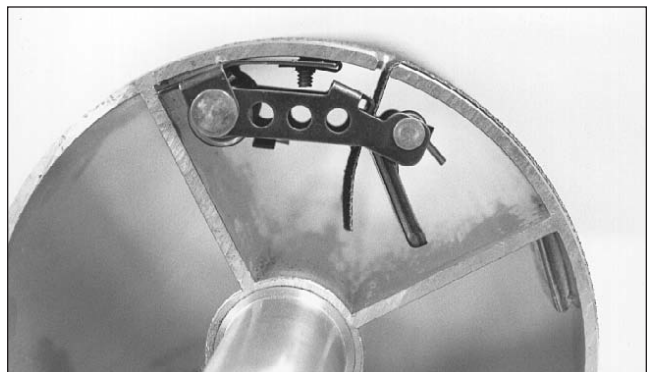

Fig. 12-i. Reset take-up as needed as strip stretches.

OPERATING YOUR SUPERMAX

Before using your SUPERMAX drum sander, review the previous pages in this manual on initial set-up and adjustment. In this section, you will learn how to operate the machine. Note that connecting the machine to an adequate dust collection system is necessary before operating the unit.

BASIC OPERATING PROCEDURES

After you have selected and installed abrasive strips, and connected the machine to a dust collection system, you are ready to begin to use the SUPERMAX. The basic operating procedure for all of the SUPERMAX models is as follows:

1. Set depth of cut.
2. Start drum(s).
3. Start conveyor and select feed rate.
4. Start dust collector system.
5. Feed stock through unit.

To feed stock through the SUPERMAX, rest and hold the board to be sanded on the conveyor table, allowing the conveyor belt to carry the board into the drum(s). Once the stock is halfway through, reposition yourself to the outfeed side of the machine to receive and control the board as it exits the unit.

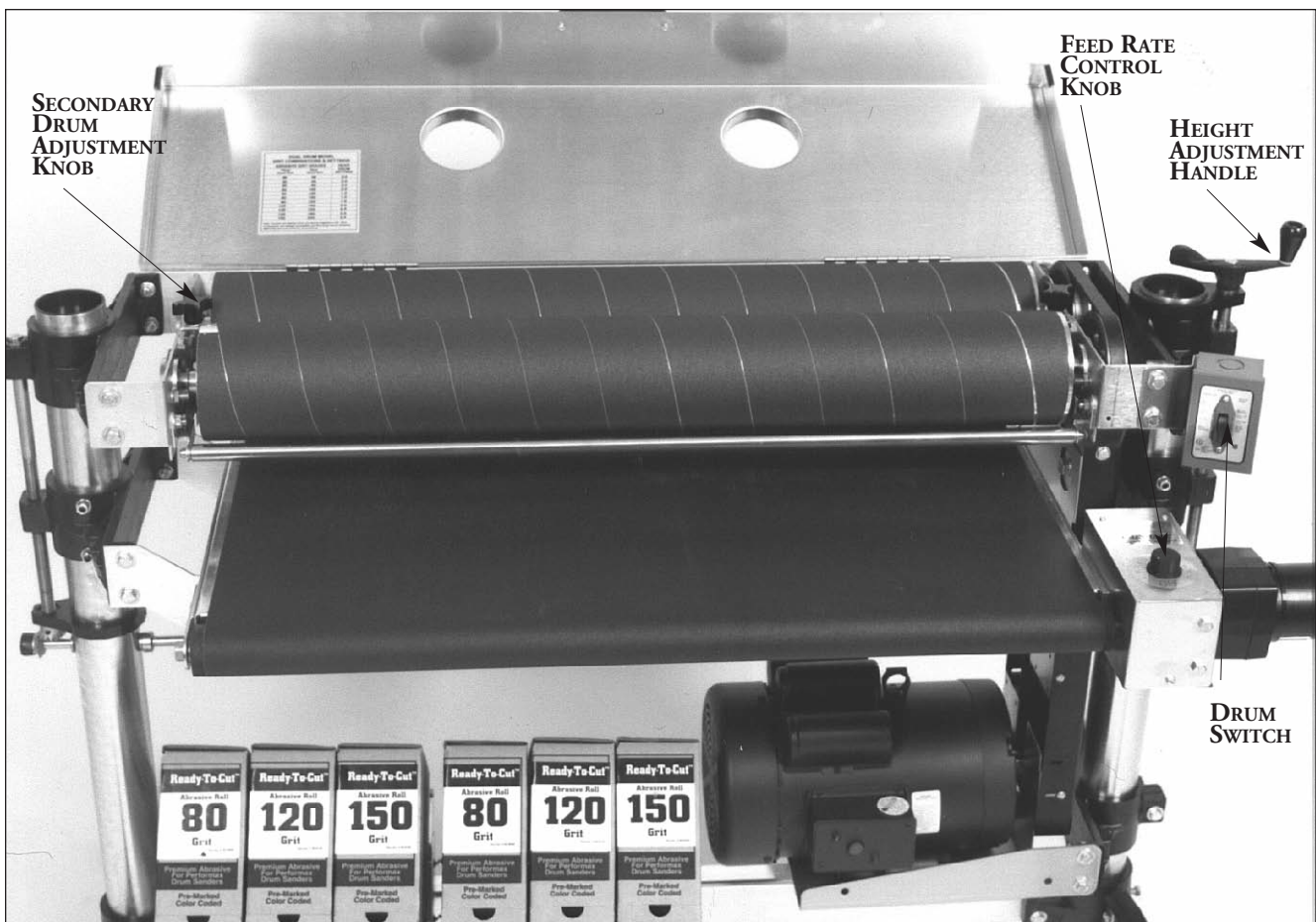

Fig. 13. SUPERMAX operating controls.

SETTING THE DEPTH OF CUT

Adjusting the SUPERMAX for the proper contact between the abrasive and the stock determines the mechanical depth of cut. **Determining the depth of cut is the most important set-up procedure** before operating the SUPERMAX sander. It may take some experimentation to determine the proper depth of cut, given the variables of abrasive grit, type of wood, and feed rate. For best results, use scrap wood to practice sanding and to develop skill and familiarity with the machine before doing finish work.

A good rule of thumb when sanding with grits finer than 80 is to raise the conveyor table so the drum(s) contacts the workpiece but still can be rotated by hand. When using grits coarser than 80 grit, you can raise the conveyor table slightly more. However, a combination of several variables will determine the proper depth of cut to use, including the following:

1. Abrasive type and grit size.
2. Width of the piece being processed.
3. Hardness of the piece.
4. Feed rate of the conveyor belt.

If your SUPERMAX is a single drum model, the depth of cut is controlled by the table height adjustment handle which raises or lowers the conveyor table under the drum. If your machine is a dual drum version, the depth of cut of the primary drum is also adjusted by the table height adjustment handle.

On dual drum units, the depth of cut of the secondary drum is controlled by the two adjustment knobs (analog indicators) located on both sides of the drum. The drum adjustment knobs allow proper depth of cut with virtually any abrasive grit combinations on the drums. The two drums are normally both used during sanding operations, but either the primary or secondary drum can be used alone.

Single or Primary Drum. To adjust the drum of single drum models, or to adjust the primary drum of dual drum models, set the drum height equal to the thickness of the piece to be processed. This is most easily done as follows: Lower the conveyor table to a depth greater than the thickness of the board. **Do not start the drum at this time.** Start the conveyor and feed the board until it is

beneath the drum(s). Raise the conveyor table so the drum(s) contact the board but the drum(s) can still be rotated by hand. Continue to run the board through the machine. This is the setting for the first sanding pass.

The depth of cut can be measured on the depth gauge, or by fractions of a revolution of the height adjustment handle. (Note: One revolution of the handle will raise the table $3/32$ of an inch; $1/3$ of a turn will equal $1/32$ of an inch, etc.)

Secondary Drum. On dual drum models, sanding with a different abrasive grit on each drum is possible in a single pass. The coarser abrasive is wrapped on the primary (front) drum for dimensioning and surfacing of the wood, while the finer abrasive is wrapped on the secondary (rear) drum. When used in this way, the secondary drum generally is positioned just slightly lower than the primary drum so it removes the scratches left by the coarser grit on the primary drum (Fig. 14).

However, the exact depth of cut of the secondary drum will depend on the specific abrasive grits on each of the drums.

The chart on page 14 shows grit combinations and rear drum settings, can also be found under the dust cover of your machine. It suggests settings for various abrasive grit combinations; try these to start and make adjustments as necessary for your work. When adjusting the secondary drum, turn

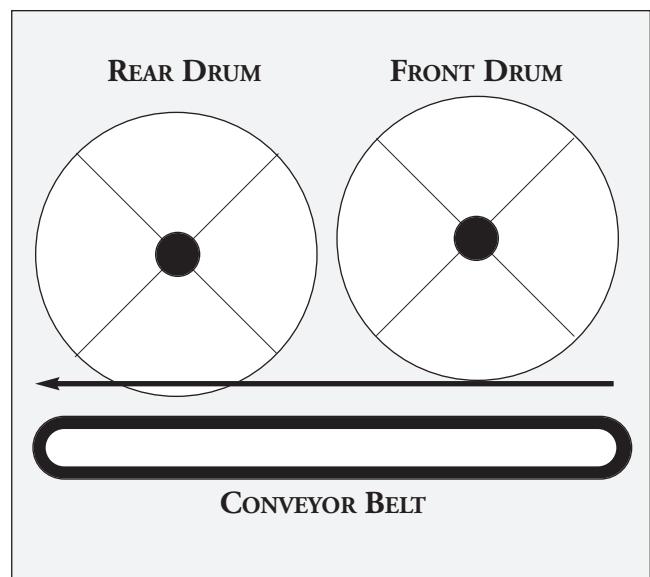

Fig. 14. Relative positions of dual drums.

DUAL DRUM GRIT COMBINATIONS & SETTINGS

ABRASIVE GRIT GRADES		REAR DRUM SETTING
FRONT DRUM GRIT	REAR DRUM GRIT	
36	36	2.0
36	60	2.5
36	80	2.5
60	80	2.0
60	100	1.5
80	100	1.0
80	120	1.0
100	150	0.5
120	150	0.5
120	180	0.5
150	220	0.5

Note: The grits and settings shown are starting suggestions only. Other combinations and settings are possible, depending on your particular circumstances.

both adjustment knobs so that the indicator needles move to the desired setting at the plus (+) end of the scale. (See Fig. 9, page 8.) The depth of cut of the secondary drum should be rechecked each time a different grit combination is used.

On dual drum machines, fine-tuning the rear drum settings can help improve performance. Here is a quick way: Raise the rear drum so it is higher than the front drum, with the indicators showing a -3 setting. Place the stock to be sanded under the front drum. Then raise the conveyor table so the front drum contacts the wood, but still can be rotated by hand. Sand the piece with the front drum and stop the machine. Then insert the stock in from the back so it is under the rear drum only. Turn down the rear drum using the plastic adjustment knobs on each side. Lower the rear drum until it contacts the stock but still can be rotated by hand. Use this setting, and note the readings on the depth indicators for future reference.

DISENGAGING THE DRUMS

On dual drum models, either the primary (front) or secondary (rear) drum may be disengaged so that the other drum can be used alone. To use the pri-

mary drum as a single-drum sander, disengage the secondary drum by raising it to the -2 setting on the indicators on both sides. To use the secondary drum alone, lower it to the +4 setting on both sides. In this mode, the table height adjustment handle is used to determine the depth of cut, which will be limited to about 1/32 of an inch before the primary drum starts contacting the work piece.

SELECTING INTELLISAND FEED RATES

Selecting the proper feed rate is essential to proper finish sanding. The variable feed rate control of the conveyor belt adjusts the load on the machine; it can be infinitely adjusted for maximum operating performance. A faster feed rate allows faster sanding but fewer revolutions of the drums per inch of sanding. A slower feed rate provides more revolutions of the drum per inch of sanding to allow a greater depth of cut and smoother sanding.

The Intellisand control (See Fig. 15) continuously monitors the load on the drum motor and automatically regulates the speed of the conveyor motor to maintain the highest feed rate without overload. If the load on the drum motor increases, the Intellisand control will decrease the conveyor feed rate and will stop the conveyor under extreme conditions. If the load on the drum decreases, the SandSmart control will increase the feed rate but WILL NOT increase it faster than the manual setting on the switch dial.

For abrasive planing and thicknessing, the feed rate can be set at any speed after adjusting for the proper depth of cut. If the load on the drum motor approaches its optimum due to inconsistent stock, the feed rate will automatically slow down. As the load on the drum motor decreases, the feed rate will automatically increase to its original setting.

When finish sanding with grits finer than 80, the best finish will be achieved if the conveyor does not change speeds during operation. While the Intellisand control will slow the feed rate when the main motor reaches its optimum, it is advisable to operate below the regulation point. When the red indicator light comes on, the Intellisand control has detected too great a depth of cut and/or too fast a feed rate. This change in conveyor speed may leave a detectable mark on finish surfaces. If a mark is visible, make adjustments by slowing conveyor and/or lessening the depth of cut and run the stock through again.

Begin experimenting with the feed rate set at about 40% to 50% of maximum. The best feed rate will depend on a number of factors, including type of stock, grit and depth of cut used, and whether the stock is feed directly in line with the conveyor bed or at an angle. If you observe a ripple effect on the stock, slow down the feed rate. If the finish is smooth and the machine is not overworking, you can experiment with using a faster feed rate.

Also try a faster feed rate if the stock you are working begins to show burn marks. With cherry, hard maple and some other hardwoods, using a shallower depth of cut and a faster feed rate will help minimize burn marks. Slightly angling the stock as it is fed into the machine may also help prevent burning the stock.

Because of the wide range of variables, it is important to experiment with your specific conditions and make adjustments to achieve the optimum feed rate. If problems occur, first check the depth of cut and/or adjust the feed rate. Refer to **Troubleshooting Your SUPERMAX** in this manual, page 19.

USING THE DEPTH GAUGE

The depth gauge (see Fig. 16) measures the distance between the conveyor table and the sanding drum for thickness dimensioning of boards. To calibrate the depth gauge, raise the conveyor table until the drum(s), wrapped with abrasive, touches the con-

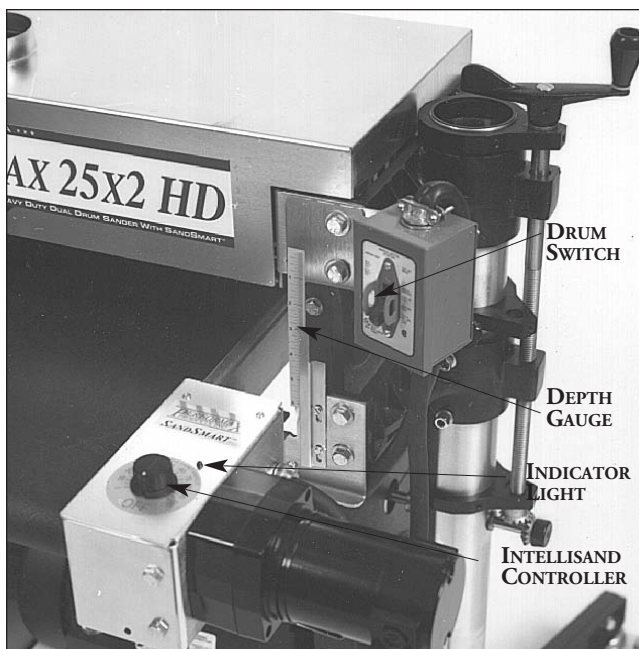

Fig. 15. Intellisand Controller and depth gauge.

veyor table. Loosen the two slotted screws holding the indicator needle to the table mount bracket (Fig. 16). Raise or lower the indicator needle to read at zero and tighten the two slotted screws.

USING THE PROSCALE™ DEPTH GAUGE

The ProScale depth gauge (Page 35, Fig. 45A) has its own manual. The ProScale can be calibrated by raising the conveyor until the drum(s) are touching the conveyor and zero the readout. Another calibration method is to sand a piece of wood, measuring the thickness of the wood and change the reading on the ProScale. See included ProScale manual for details on calibrating and operation.

USING THE DEPTH STOP

A depth stop (Fig. 16) is located on the column tube just above the table support casting on the right (inboard) side. The depth stop casting has a locking knob located on one side of the casting. To operate the depth stop: Determine desired thickness of sanded part by either referencing the depth gauge or sanding a part and measuring the thickness of the sanded part. At this sanding thickness, position the depth stop along the column tube with the gauge resting on the table support casting and tighten the locking knob on the depth stop. This will give a desired exiting thickness to the material and help prevent under dimensioning.

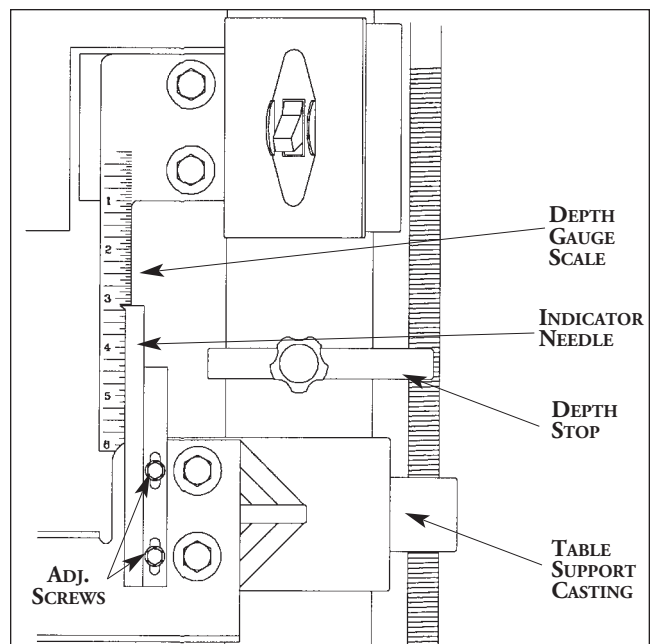

Fig. 16. Depth gauge components, on some models.

SELECTING DRUM ABRASIVES

It is important to select the proper grit of abrasives for the type of sanding being performed to achieve maximum sanding results. As with any sanding operation, first begin sanding with a coarser grit, depending on the roughness of the stock or the amount of stock to be removed. Then progressively work toward finer grits. The chart below shows the general uses for the various grits. Performax Products offers abrasives in the ten different grits shown.

Selecting Abrasive Grits. The amount of stock to be removed is a major consideration when choosing the grit grade to start with. Grits 24, 36, 50, and 60 are primarily designed for stock removal. Grits 24 and 36 will remove the most material in one pass, whether you are doing abrasive planing, cleaning up glued panels, or flattening stock. Grits from 100 through 220 are primarily finishing grits designed to remove the scratch pattern from the previous grit used. For best results, never skip more than one grit grade when progressing through a sanding sequence.

For fine work, such as furniture, try not to skip any grit grades during the sanding process. In general, premium quality abrasives such as Genuine Performax abrasives will produce a better finish

with a less noticeable scratch pattern. **Caution:** Grits that are too fine can sometimes burnish the wood and leave a glossy surface which will not accept stains evenly. This will vary by type of wood. Oak, for example, is susceptible to burnishing because of its open pores.

Selecting Grit Combinations. The chart shown on page 14 is a general guide to consult when selecting grits to use on dual drum machines and setting the rear drum. This chart is also provided under the dust cover on the SUPERMAX for quick reference. The first column suggests grits for the primary (front) drum of dual drum models, while the second column suggests a corresponding grit to use on the second (rear) drum. The third column suggests depth settings to try on the rear drum, depending on the grit used. The setting values are based on a "0" reading when the drum contacts the work piece but still can be rotated by hand.

Note that the grits and settings are starting suggestions only. Other combinations and settings are possible, depending on your particular circumstances. It is a good idea to keep records of the combinations you use and their results. Keeping these records handy will help you select the best combinations of grits for future work.

ABRASIVE SELECTION GUIDE

GRIT	COMMON APPLICATION
24 Grit	Abrasive planing, surfacing rough-sawn boards, maximum stock removal, glue removal.
36 Grit	Abrasive planing, surfacing rough-sawn boards, maximum stock removal, glue removal.
50 Grit	Surfacing and dimensioning boards, trueing warped boards.
60 Grit	Surfacing and dimensioning boards, trueing warped boards.
80 Grit	Light dimensioning, removal of planer ripples.
100 Grit	Light surfacing, removal of planer ripples.
120 Grit	Light surfacing, minimal stock removal.
150 Grit	Finish sanding, minimal stock removal.
180 Grit	Finish sanding only, not for stock removal.
220 Grit	Finish sanding only, not for stock removal.

TIPS FOR MAXIMUM PERFORMANCE

The versatility designed into the SUPERMAX drum sander allows it to be used for a wide-ranging variety of tasks that will boost the return on your investment. For example, its capabilities range from taking the place of a planer to thickness rough stock, all the way to speeding up fine sanding work often done with slower, dust-generating hand sanders.

Learning to use its multiple adjustments and controls will allow you to fine-tune the machine for maximum results, regardless of the job to be done. The best results come from experimenting with different abrasive combinations and machine adjustments to fit the job at hand. Following is a listing of useful tips which can help you improve performance of your sander.

Dust Collection. When connecting dust collectors, remember that straight pipe will not restrict airflow as much as flexible tubing. Also, Ys and elbows will restrict airflow less than Ts. When connecting to the dual ports of the SUPERMAX 37 or 37x2, use a larger diameter pipe to the machine, and then split to two 4" hoses connected to the ports. An alternative is to use two separate 4" lines running to the ports; **do not** use only one 4" line and split it by the machine.

Multiple-Piece Sanding Runs. When abrasive planing (or thickness sanding) a run of similar pieces that you want to have the same thickness, it is best to determine the thickness of the thinnest piece and process all pieces to that same thickness. Be aware that the sander will remove cups and crowns in the work piece; consider this when measuring and processing stock to the same thickness.

Sanding Multiple Pieces At Once. When sanding multiple pieces simultaneously, make sure to stagger (step) the pieces across the width of the conveyor belt. This provides better contact with the tension rollers. Try to only process multiple pieces of similar thickness. If there is a significant thickness difference, the thinner pieces can slip on the conveyor belt if they do not contact the tension rollers. Also note that pieces thicker than 3/4" should be longer than the minimum normally recommended to prevent tipping of the stock (see

Specifications, page 37). Going to longer pieces is especially important when sanding boxes or other tall, short or light stock.

Edge Sanding. When edge sanding, the Performax sander will mimic the opposite edge of the stock which is laying on the conveyor belt. Because of this, it is important for the stock edge to have been ripped at the proper angle to the face before the sanding process. When edge sanding stock that is less than 3/4" wide, or more than 2" high, it is good procedure to stack and clamp several pieces together to prevent them from slipping or tipping on the conveyor belt.

Sanding Imperfect Stock. When sanding stock with a cup or crown, place the crown up. This will stabilize the stock to help prevent tipping or rocking during sanding. (After the crown has been removed and the top is flat, turn the stock over and sand the opposite side.) To avoid personal injury, take special care when sanding stock that is twisted, bowed, or otherwise varies in thickness from end to end. If possible, support such stock as it is being sanded to keep it from slipping or tipping. Use extra roller stands, help from another person, or hand pressure on the stock, to minimize potentially hazardous situations.

Face Frames & Raised Panel Doors. It is very important to have the proper abrasive contact when doing this type of sanding. If the machine is set to take an excessive depth of cut, the result can be a gouge or dip as the drum goes from sanding the rails at full width to sanding just a few inches of width on the stiles. To prevent this problem, for example, make sure that when using abrasives finer than 80 grit the drum is in contact with the wood but can still be spun by hand. If there is room, angling the stock on the conveyor belt can also help. Slowing the conveyor feed when coming to a rail in the stock can help prevent a dip or gouge. This allows the abrasive to work the wider width with less effort, and to achieve better consistency of the finished surface.

Stock Feeding Angle. Some pieces, because of their dimensions, will need to be fed into the machine at a 90° angle (perpendicular to the

drums). However, even a slight offset angle of the stock will provide for more effective stock removal. The optimum feeding angle for stock removal is about 60° (see Fig. 17). Angling the workpiece for stock removal provides other advantages, such as less loading of certain areas of the drums due to glue lines or mineral streaks in the stock, more even wear of abrasive strips, potentially faster feed rates, and lighter loads on the motor.

Note that to get the best final finish, however, the stock should be fed through the machine so it will be sanded in line with the grain of the wood on the final one or two passes.

Cleaning Abrasive Strips. Regularly clean the abrasive strips on the drums with commercially available cleaning sticks, following the manufacturer's directions. (See Fig. 18.) Cleaning sticks are available from your dealer or from SuperMax Tools. When cleaning, also brush the stick crumbs from the drum while it is still rotating. **Important:** Wear eye protection, tight-fitting clothes and keep alert during this operation to avoid injury. Cloth-backed abrasives can be cleaned by soaking in paint thinner or mineral spirits for 20 minutes to 1 hour, then using a brush to remove any build-up or burns. Dry the abrasive strips completely before reuse. In some cases build-ups resulting from burns can be removed with Plexiglas held on edge

over a rotating drum. Have dust collection turned on when cleaning.

Stretching Abrasive Life. When sanding metal or solid surface, MDF, or particle board, ceramic abrasive (Regalite™) will last longer than aluminum oxide and also allow a more uniform finish. Abrasive life can also be increased on SUPERMAX machines by removing the abrasive strip from the drum and reversing it. To do this, remove the strip and use what was the trailing end as the starting end on the left (outboard) side of the drum. Reversing the strip will provide a fresh set of cutting edges on the drum.

Keeping The Machine Clean. For best results, make cleaning the machine a regular shop procedure. Allowing excess build-up of dust and debris can adversely affect performance through the loading of the abrasives, slippage on the conveyor table, and/or the accumulation of material inside the drums which can throw off the center of balance. Leave the dust collector on when cleaning dust from the drums. Also brush the conveyor belt after cleaning operations. If not cleaned, the conveyor belt could allow stock to slip during sanding operations.



Fig. 17. Offset stock feeding angle.



Fig. 18. Cleaning abrasive strips.

TROUBLESHOOTING YOUR SUPERMAX

Any operating problems with the SUPERMAX drum sander will likely occur most often during the period that you are becoming familiar with its components and their adjustments. If you are experiencing a problem affecting the machine's

sanding performance, check the following listings for potential causes and solutions; it may also pay to review the previous sections in this manual on setting up and operating your machine.

TROUBLESHOOTING GUIDE: MOTORS

Problem	Possible Cause	Solution
Motors do not start.	<ol style="list-style-type: none"> 1. Main power cord unplugged from receptacle. 2. Circuit fuse blown or circuit breaker tripped. 3. Drum motor thermal overload protector tripped (single phase only). Magnetic starter thermal overload protector tripped (SUPERMAX SE single and three phase models). 	<p>Plug in primary power cord.</p> <p>Replace fuse or retrip breaker (after determining cause).</p> <p>Reset after allowing to cool; check circuit and/or reduce load or slow feed rate.</p>
Drum motor overloads.	<ol style="list-style-type: none"> 1. Inadequate circuit. 2. Machine overloaded. 	<p>Check electrical requirements.</p> <p>Use slower feed rate and/or reduce depth of cut.</p>
Conveyor motor oscillates.	<ol style="list-style-type: none"> 1. Motor not properly aligned. 2. Shaft collar worn. 3. Drive roller bent. 	<p>Loosen housing bolts, run motor, retighten bolts.</p> <p>Replace shaft collar (page 5).</p> <p>Replace drive roller (page 31).</p>
Drum motor or conveyor gear motor stalls.	<ol style="list-style-type: none"> 1. Excessive depth of cut. 	<p>Reduce depth of cut; reduce feed rate.</p>

TROUBLESHOOTING GUIDE: MACHINE

Problem	Possible Cause	Solution
Abrasive strip comes off drum.	1. Slack in abrasive strip on drum.	Remove slack in strip (page 10).
	2. Abrasive improperly installed.	Read section on abrasive installation (page 10).
Abrasive strip loose.	1. Strip caught on inside edge of slot or on inboard side of drum.	Readjust strip end in slot and/or trim abrasive edge.
	2. Strip not cut properly.	Recut and install abrasive strip (page 10).
Abrasive loads up prematurely.	1. Excessive depth of cut.	Reduce depth of cut.
	2. Excessive feed rate.	Use slower feed rate.
	3. Inadequate dust collection.	Increase air flow at dust ports.
	4. Inadequate abrasive.	Use open-coat abrasive.
	5. Stock fed at 90° angle to drum.	Angle stock to avoid resin line build-up.
Conveyor rollers run intermittently.	1. Shaft coupling loose.	Align shaft flats of gear motor and drive roller, and tighten shaft coupling set screws.
Conveyor belt slips on drive roller.	1. Improper conveyor belt tension.	Adjust belt tension (page 8).
	2. Excessive depth of cut.	Reduce depth of cut; reduce feed rate.
Board slips on conveyor belt.	1. Excessive depth of cut.	Reduce depth of cut.
	2. Tension rollers too high.	Lower tension rollers (page 28).
	3. Excessive feed rate.	Reduce feed rate.
	4. Dirty or worn conveyor belt.	Clean or replace conveyor belt (page 31).

TROUBLESHOOTING GUIDE: MACHINE (Continued)

Problem	Possible Cause	Solution
Conveyor belt tracks to one side, or oscillates from side to side.	1. Belt out of adjustment.	Readjust belt (page 8).
	2. Drive or driven conveyor belt rollers misaligned.	Readjust (page 8).
	3. Conveyor table not flat and square.	Readjust by leveling with leg glides (page 7).
	4. Conveyor belt worn or defective.	Replace conveyor belt (page 31).
	5. Roller bushings elongated due to excessive wear.	Replace bushings (page 31).
Table height adjustment works improperly.	1. Improper adjustment of height control.	Readjust height control (pages 9, 24, 26).
Drum drive belt slips.	1. Improper V-belt tension.	Increase drive belt tension.
Knocking sound while running.	1. Bearing out of alignment.	Realign bearing (page 33).
	2. V-belt worn.	Replace V-belt (page 32).
	3. Loose weight in drum.	Glue weight back in place.
	4. Pulleys wobbling or out of round.	Replace pulley (page 34)
	5. Set screws loose in pulley or bearing.	Retighten or replace set screws.
	6. Abrasive fastener on drum loose (without abrasive strip in place).	Insert abrasive paper, or replace fastener (page 10).
	7. Bearing worn. (idler pulley bearings).	Replace bearing (page 33).

TROUBLESHOOTING GUIDE: OPERATIONS

Problem	Possible Cause	Solution
Rippled sanded surface (non-uniform ripples).	1. Uneven feed rate.	<p>Check for these conditions and refer to previous section, Troubleshooting: Machine.</p> <ul style="list-style-type: none"> • See Selecting Intellisand Feed Rates (page 14). • Conveyor belt slipping on drive roller. • Board slipping on conveyor belt. • Conveyor gear motor stalling. • Excessive V-belt tension (page 5). • Set screw loose on shaft coupler between gear motor and conveyor. • Conveyor bushings dry; lubricate.
Rippled sanded surface (uniformly spaced ripples).	<p>1. Excessive feed rate.</p> <p>2. Excessive depth of cut.</p> <p>3. Sander vibration.</p>	<p>Reduce depth of cut or reduce feed rate</p> <p>Reduce depth of cut or reduce feed rate.</p> <p>Check for these conditions:</p> <ul style="list-style-type: none"> • Loose bolts or bearing and pulley set screws; retighten. • Dirty drum; clean inside. • Excessive V-belt tension; reduce tension (page 5). • Worn V-belt; replace (page 32). • Warped driven pulley, replace (page 34).

TROUBLESHOOTING GUIDE: OPERATIONS (Continued)		
Problem	Possible Cause	Solution
Sniping of wood (gouging near end of board).	<ol style="list-style-type: none"> 1. Tension rollers set too far down. 2. Stock not supported properly during infeed or outfeed. 3. Conveyor drive or driven rollers higher than conveyor bed. 	<p>Reset tension rollers (page 28).</p> <p>Support stock with roller stands, tables or benches.</p> <p>Readjust rollers (page 28).</p>
Burning of wood.	<ol style="list-style-type: none"> 1. Feed rate too slow. 2. Excessive depth of cut for grit used. 3. Excess build-up on abrasive strips. 4. Abrasive is too fine. 5. Abrasive strips overlapped. 6. Drum out of alignment. 	<p>Increase feed rate.</p> <p>Reduce depth of cut or increase grit coarseness.</p> <p>Reduce depth of cut; clean strips or replace.</p> <p>Replace with abrasive of coarser grit.</p> <p>Rewrap strip without overlap.</p> <p>Realign drum (page 26).</p>
Gouging of wood.	<ol style="list-style-type: none"> 1. Conveyor belt is too loose. 2. Excessive depth of cut. 3. Wood slipping on conveyor due to lack of contact. 4. Abrasive is too fine. 	<p>Adjust belt tension (page 8).</p> <p>Reduce depth of cut.</p> <p>Use alternate feeding procedure (page 17).</p> <p>Replace with coarser grit.</p>
Unsanded ridge along length of piece (sandpaper appears clean).	<ol style="list-style-type: none"> 1. Grit has been removed from backing. 	<p>Avoid this area of drum, or change abrasive strips.</p>

SERVICING YOUR SUPERMAX

The basic adjustment procedures for your machine are covered under Setting Up Your SUPERMAX Sander, page 6. Review that section first. If following the general instructions does not solve a specific problem or result in smooth operation, also check Troubleshooting Your SUPERMAX, page 19. Below are suggested procedures to follow when more thorough readjustment or replacement is necessary.

ADJUSTING HEIGHT CONTROLS

Height adjustment problems may be the result of not loosening the set screws in the table support castings before attempting operation. (This is covered on page 5 of this manual, and also on the separate unpacking sheet which was shipped with your machine.) If the set screws were not loosened as instructed, do so now before proceeding further. Also make sure all moving parts of the height adjusting mechanism are well lubricated, including the miter gears, column tubes, and threaded height adjusting screws.

When troubleshooting the height adjustment mechanism, first check the conveyor table for level (see page 7). Then test the height adjustment mechanism (See Fig. 19). If it does not operate

easily, further adjustments may be necessary, as outlined below. Following these steps should result in smooth operation.

Readjustment Procedure

1. Loosen the set screws located at the front of the table support castings (Fig. 19).
2. Lubricate thoroughly by applying penetrating lubricant to the table support castings where they contact the column tubes, and to all contact points of adjusting screws and cross bar (Fig. 20). Also apply oil or grease to the miter gears.
3. If the height adjustment feels stiff, check for misalignment of adjusting screw supports and the drum support castings which could cause binding on the adjusting screw rods (Fig. 19). These castings can be adjusted by loosening the set screws which secure them to the column tubes. Realign the adjusting screw supports by loosening the two set screws that hold them to the column tubes and rotate to the proper position.
4. The adjusting screw supports located immediately below the height adjustment handle and the

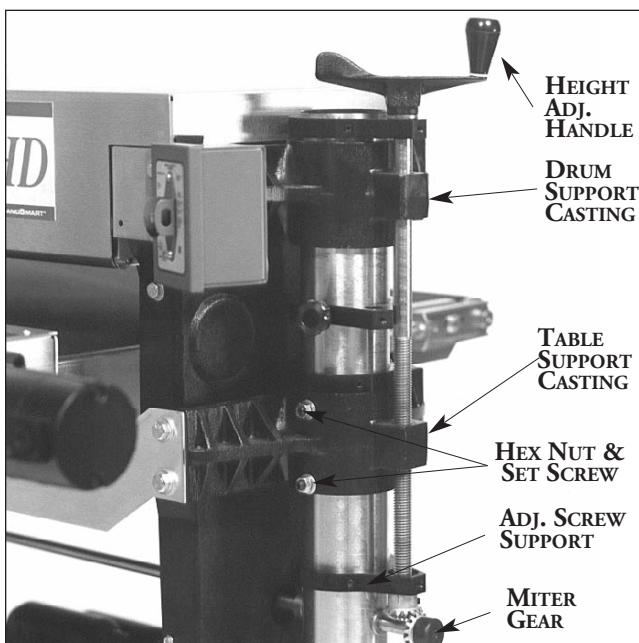

Fig. 19. Table support casting set screws.

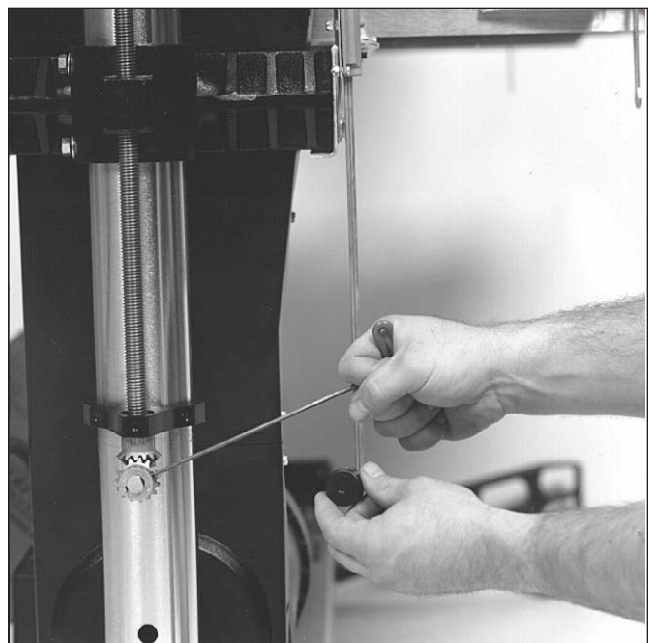

Fig. 20. Adjusting miter gears for proper mesh.

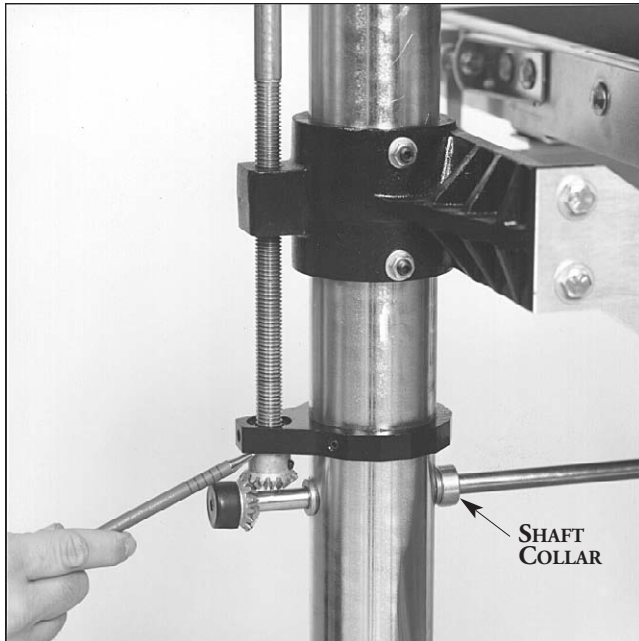

Fig. 21. Miter gear below adjusting screw support.

left (outboard) drum supporting casting (Fig. 19) must both be set at the proper height along the column tubes so the height adjusting screws provide for proper miter gear alignment. Before adjusting these parts, tighten one set screw in the table support castings (Fig. 19) to hold the height adjusting screw in position during adjustment.

Also check to see that the column tubes are centered inside the bore of the table support castings (Fig. 19). If not, loosen the casting bolts and tighten the set screws at the front of table support casting to center the tube. Retighten the bolts and loosen the set screws.

5. If the height adjustment mechanism feels rough, check the miter gear (Fig. 20) alignment. The miter gears can be adjusted on their shafts by loosening the set screws on the gears. Check and adjust so that the gear mesh is not too tight or too loose, and that the gear teeth align with the opposing gear. Note that the shaft collars located on the cross bar (Fig. 21) should be adjusted to control the lateral movement of the cross bar to maintain accurate miter gear alignment and mesh.

The mesh of the miter gears should be smooth and even. If not, adjust the gears for good mesh (Fig. 20). Measure the space between the miter gear and the adjusting screw support that holds the height adjusting screw in place (Fig. 21). The

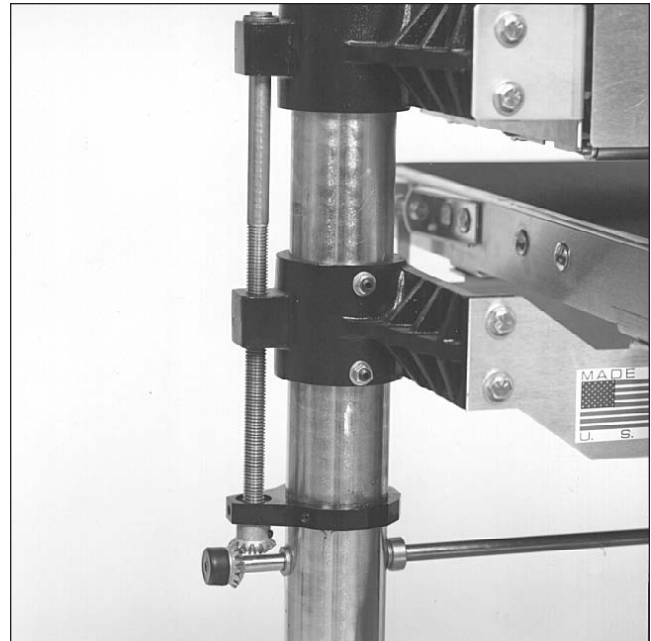

Fig. 22. Height controls on outboard side.

distance should be $1/32$ " or less. If there is excessive space, move the adjusting screw support to the proper distance above the miter gear and retighten. Loosen the set screws in the table support castings (Fig. 19) and test for smooth operation.

6. Next, check the position of the height adjusting screw rods. First raise the conveyor table. Then check the E-clip and washer at the top of the height adjusting screw on the left (outboard) side, and under the height adjustment handle on the right (inboard) side of the machine. On both sides, the washer and E-clip (or washer only) should be snug on the casting just below the washer. If there is a space between the washer and the casting, tighten one set screw in each of the table support castings. If one height adjusting screw is loose, remove the miter gear from the cross bar on that side. Turn down the threaded height adjusting screw rod until it is snug with the washer. Make sure both sides are snug on top. Reinstall the miter gear and tighten. Loosen the set screws in the table support castings and test for smooth operation.

ADJUSTING TABLE SUPPORT CASTINGS

If the conveyor table does not raise and lower easily, measure the distance between the top of the base column support and the bottom of the table

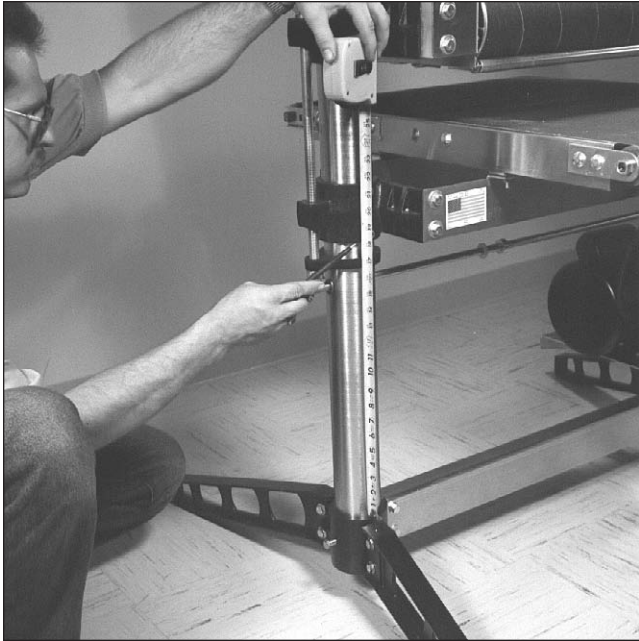

Fig. 23. Adjusting table support castings.

support casting (Fig. 23) on both the right (inboard) side and the left (outboard) side of the machine. Compare these measurements; they should be within 1/16". If not, disengage the miter gear on the right (inboard) side of the cross bar. Adjust the conveyor bed height using the height adjustment handle to get the same measurement on both sides. Then re-engage the miter gear on the cross bar.

If the conveyor table is still difficult to raise or lower, the table support castings may need to be recentered on the column tubes. To do this, loosen the 3/8" x 1" hex head bolts in each table support casting, adjust and tighten the set screws to hold the casting in position. Then tighten the hex head bolts and loosen the set screws.

ADJUSTING SANDING DRUMS

After any adjustments of the castings on the columns, check to make sure the sanding drums are in alignment. To begin realignment of the sanding drum(s), first remove the abrasive strip from the drum. Release the V-belt tension from the motor by loosening the pinch bolt of the motor support casting (see 8, Fig. 5, page 6). Loosen two screws in lower belt guard. Slide the motor mount up the column tube and retighten the pinch bolt. After the feed table has been leveled, loosen all four tension roller suspension bolts



Fig. 24. Comparing drum support casting heights.

(see 1, Fig. 28, page 28). Raise the tension roller suspension assembly (2, Fig. 28) to its highest position so that the tension rollers are positioned higher than the bottom of sanding drum(s). Then retighten the four tension roller suspension bolts to hold the tension rollers in that position during drum alignment.

Primary Drum Alignment. Using a flat piece of wood or a steel rule as a thickness gauge, insert it between table and primary (front) drum and adjust the table height to gauge the thickness. Raise the table just so the drum can be barely turned by hand. Measure at both sides of the drum to check that the primary drum is parallel to the table. To adjust the primary drum alignment, loosen both set screws at the front of the right (inboard) drum support casting (Fig. 24) and raise or lower the casting on the column tube to correct drum alignment. Retighten the set screws and recheck the alignment. **Note:** Do not loosen the set screws of the left (outboard) drum casting as this will cause miter gear misalignment.

Achieving a very precise primary drum alignment can be accomplished by disengaging the right (inboard) miter gear (Fig. 25) from the height adjustment cross bar, and using the height adjustment handle to finely raise or lower the inboard side of the table to achieve parallel align-

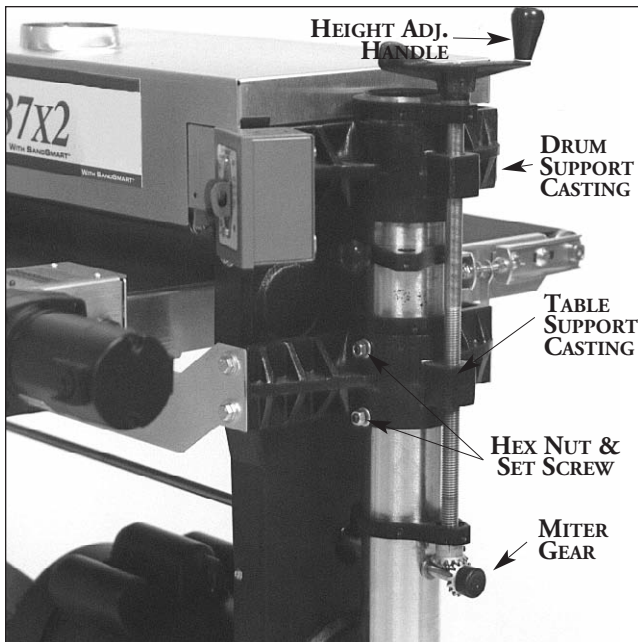

Fig. 25. Adjusting primary drum.

ment of the drum (see **Adjusting Table Level**, page 7). Note that if only fine adjustment of the primary drum alignment is required, these adjustment procedures can be used to correct alignment without relieving V-belt tension or adjusting tension rollers as described above.

The above procedure is all that is required to align the drum on a single drum SUPERMAX sander. If yours is a dual drum machine, follow the procedure below.

Secondary Drum Alignment. With the primary drum properly aligned, use the same thickness gauge and insert it between the secondary drum and the table from the back side of the machine. (Again, adjust the contact between the drum and guide so the drum can barely be turned by hand.) Measure at both sides of the drum to check that the secondary drum is parallel to the table. To adjust the secondary drum alignment, use the right and left drum adjustment knobs (Fig. 27) to raise or lower each side of the drum.

At this point both the primary and secondary drums will be aligned parallel to the table and both drums will be at the same height above the table. Set the secondary drum adjustment indicators by loosening the hex nut (Fig. 27), moving the scale so that the zero mark is directly under the needle, and retightening the hex nut. Zero the indicator for

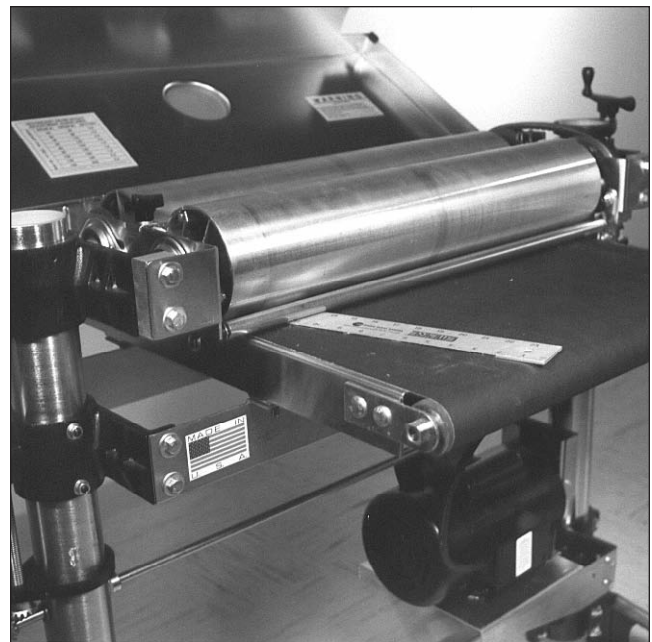

Fig. 26. Using thickness gauge during alignment.

other side of drum in the same manner.

Caution: Do not overtighten the hex nut of the indicator (Fig. 27). This can flare the brass bushing and render the indicator inoperable. Also, the secondary drum adjustment knobs should turn with a slight resistance to avoid any movement during operation. To adjust knob resistance, turn the knob clockwise to reveal the set screw on the

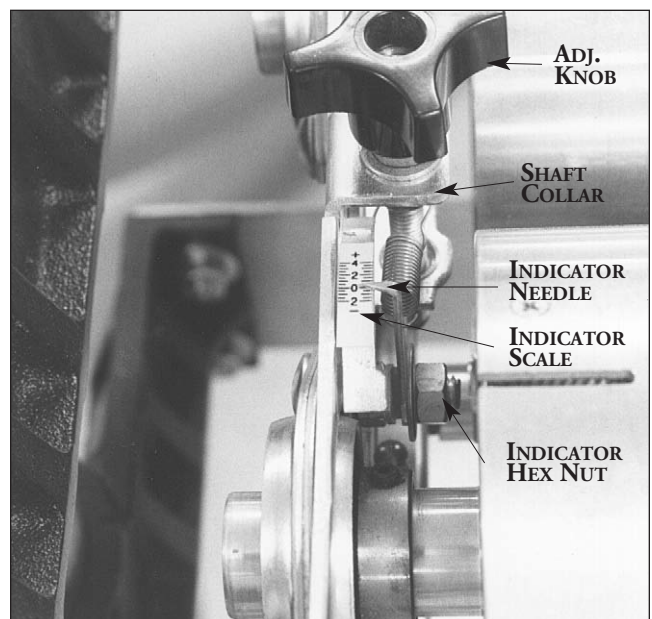

Fig. 27. Secondary drum adjustment indicator.

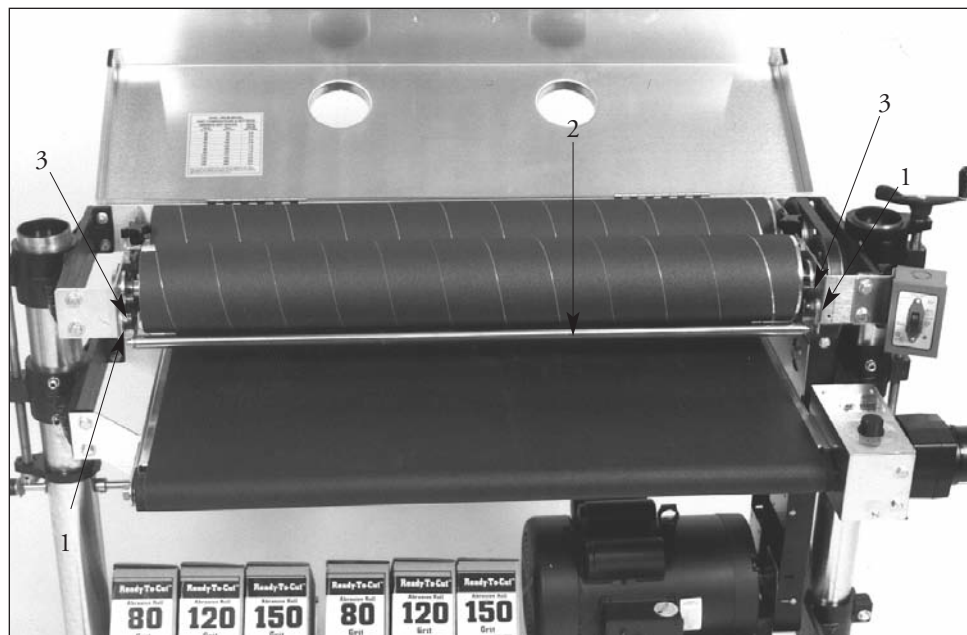

Fig. 28. Tension roller adjustment.

- 1. Tension Roller Suspension Bolts.**
- 2. Tension Roller**
- 3. Spring Retaining Screws.**

shaft collar below the bracket, then loosen the screw. Making sure the adjustment knob is tightly seated on top of the bracket, raise the shaft collar up against the bracket from below and tighten the set screw. **Note:** The nut of the rear bolt on the rear (secondary) drum bearing bracket should be backed off a quarter-turn from being fully tightened. This allows the lock washer under the rear bolt on the rear bracket to be depressed slightly, but not completely. After alignment is completed, lower the motor mount to re-establish V-belt tension. Tighten two screws in belt guard.

ADJUSTING TENSION ROLLERS

With the sanding drums properly aligned, raise the table to the bottom of the sanding drums. Loosen all four tension roller suspension bolts (see 1, Fig. 28). Lower the table by one full turn of the height adjustment handle. At this position the tension roller assembly should be resting on the table with the drums suspended slightly above the table. Then retighten the tension roller suspension bolts.

Note: Too much tension roller pressure can cause snipe marks which are identified as a visible line running across the width of the board approximately 2 1/4" from the end of the board. If a snipe mark occurs on the trailing end of the board, adjust the infeed tension roller. Tension roller pres-

sure can be adjusted two ways, either by loosening the tension roller spring retaining screws (see 3, Fig. 28) or by raising the height of the tension rollers. To adjust the tension rollers to eliminate snipe marks, use this two-step procedure:

Step 1. With the sanding drums properly aligned, loosen all four tension roller suspension bolts. Raise the table to the bottom of the sanding drum(s). The tension rollers should be resting firmly on the conveyor bed. Tighten only the two rear (outfeed) tension roller suspension bolts.

Step 2. Lower the conveyor table by one full turn of the height adjustment handle. At this point, press down on the front (infeed) tension roller so it is resting on the table. Now tighten the front (infeed) tension roller suspension bolts. If there still is a snipe mark left on pieces being sanded, repeat Step 1 and Step 2, but in Step 2 lower the conveyor bed a half turn instead of a full turn.

Warning: Improperly adjusted tension rollers (i.e., those set too high, rendering them non-functional) could allow kick-back/slippage of pieces being sanded.

REPLACING SANDING DRUMS

Changing drums on the SUPERMAX is a relatively rare procedure, most often the result of external damage or damage resulting from improper settings for the stock being sanded.

To begin, disconnect power to sander. Remove the sandpaper on the drums and level the sanding drums to each other. Next, loosen the pinch bolt of the motor support casting, loosen two screws in lower belt guard, raise the motor, and retighten the pinch bolt. With this done, follow the steps below for dual drum sanders. The procedure is basically the same for single drum sanders except there is only one driven pulley and drum.

Disassembly Procedure

1. Disengage the outer belt guard cover by removing the four 10-32 screws and the two 5/16" x 1/2" bolts holding it in place. (Fig. 29). Take the V-belt off driven pulleys.
2. Level the drums to each other (see pages 7 and 8 in this manual). Then raise the conveyor bed until the drum(s) rest on the conveyor bed.
3. Remove the four 3/8" x 2 1/4" bolts from the drum support casting on the right side (see Fig.

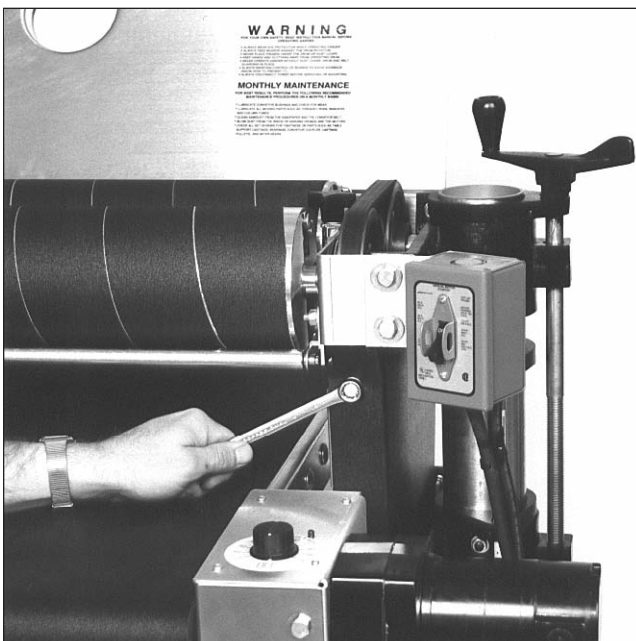

Fig. 29. Removing outer belt guard.

30). Remove on/off switch, bracket, and depth gauge.

4. Remove the top two 3/8" x 2 1/4" bolts from the drum support casting on the left (outboard) side of the sander. Loosen the bottom two 3/8" x 2 1/4" bolts from the left drum support casting, but do not remove them.

5. Lift the right (inboard) side of drums and place a 2x6 on edge under the drums (Fig. 32). Loosen and remove the V-belt pulleys from drum shafts.

Important: Make sure to note the location of the pulleys. Also measure the distance from pulley edge to the drum support casting to use as a reference when reinstalling pulleys so they will be properly aligned.

6. Loosen the set screws in the two V-belt pulleys and remove the pulleys. Next, loosen the two set screws in each of the four bearing collars (Fig. 33). Now remove the sanding drum support brackets that hold the bearings (Fig. 34). Remove the sanding drums at this time and install the new drums. If the bearings need replacing, replace them at this time (see page 33).

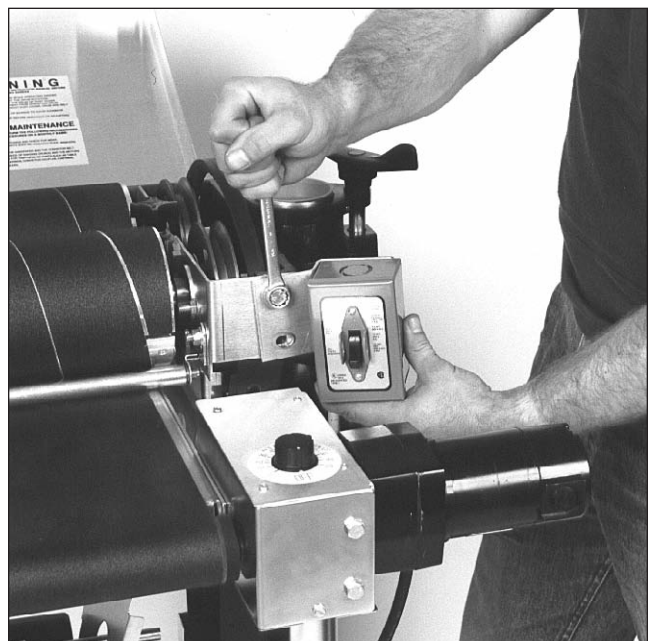

Fig. 30. Removing bolts from drum support casting.

Reassembly Procedure

1. To assemble the unit after replacing drums, install the sanding drum support brackets. Slide the drums through the bearings but do not tighten the set screws in the bearings yet. Install the V-belt pulleys, but don't tighten the set screws yet.
2. Remove the 2x6 from the conveyor bed at this time. Align the cross brace and the dust cover at



Fig. 31. Drum support casting bolts (outboard side).

this time. Install the four bolts on the right (inboard) side. Install the on/off switch with the infeed bolts and two bolts on the left (outboard) side of the sander and tighten securely.

3. Tighten the two set screws in each of the four bearing collars. Spin the drums by hand to check if they spin freely.

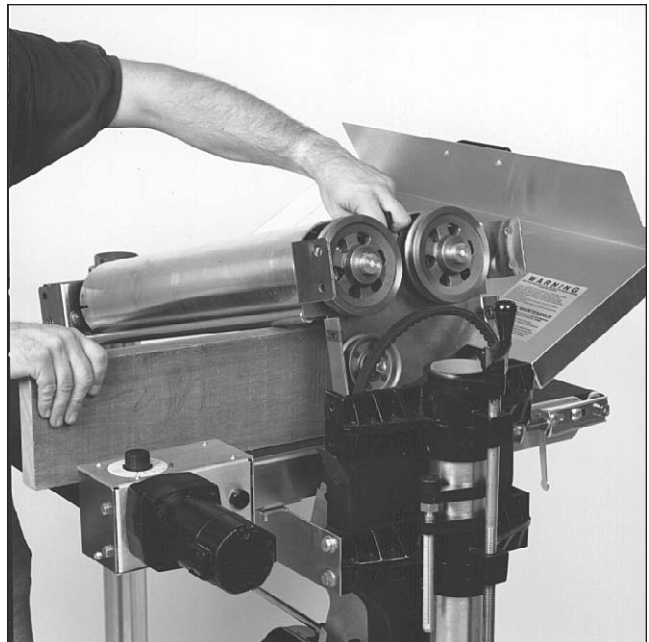

Fig. 32. Supporting drums with 2x6 on edge.

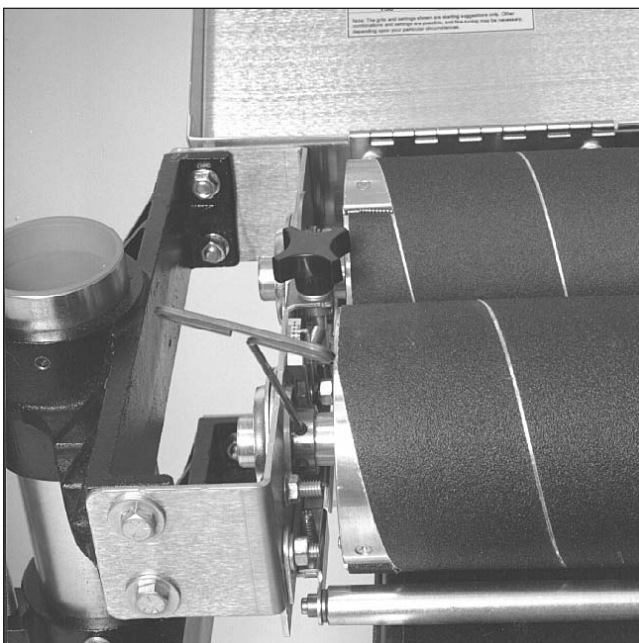

Fig. 33. Loosening drum bearing set screws.

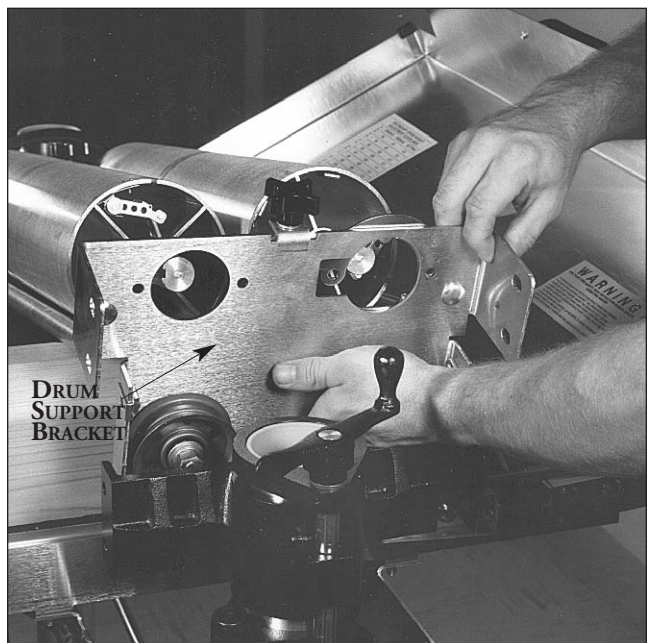

Fig. 34. Removing sanding drum support bracket.

4. Align the V-belt pulleys with the pulley on the motor and then tighten the set screws in the V-belt pulleys. Spin the drums by hand to make sure the pulleys are in proper alignment.

5. Check the alignment of the front drum to the conveyor table. If they are not parallel, level the front and then the rear drum (see pages 7 and 8) before proceeding further.

6. Readjust the tension of the V-belt by sliding the motor down and then tightening the pinch bolt in the motor support casting. Make sure all pulleys are aligned and all bolts tight before using the sander.

7. Reinstall the outer belt guard using the two 5/16" x 1/2" hex head bolts. Reinstall the lower belt guard using the two 10-32 screws and the middle, inner guard using two 10-32 screws.

REPLACING CONVEYOR BELTS

To replace the conveyor belt, the conveyor assembly must be removed from the machine. Lower the conveyor table to its lowest position with the height adjustment handle. Remove the bottom cover from control box, rotate shaft to access set screws in shaft coupler. Important: Disconnect power to sander. Loosen one set screw. Remove the four 5/16" bolts holding the conveyor motor control box base bracket (Fig. 45). Remove conveyor motor control box and place on dust cover. Loosen the conveyor take-up screws (Fig. 35 and Fig. 36) to relieve belt tension and slide the driven roller fully inward. Remove the four bolts that attach the conveyor assembly to the table mount brackets (see Fig. 36). Lift the conveyor and remove it from the machine by sliding the conveyor out toward the front of the machine. Avoid tearing the belt on any edges underneath the conveyor bed during removal. Reverse the procedure for re-installation.

Note: If the conveyor belt continually tracks to one side of the machine, first try reversing the belt on the conveyor bed. If this doesn't remedy the problem, place a level on the conveyor bed to make sure the conveyor bed is not twisted. If it is twisted, see page 7 for instructions on squaring up the bed. If squaring up the bed does not remedy the problem, proceed with the steps below:

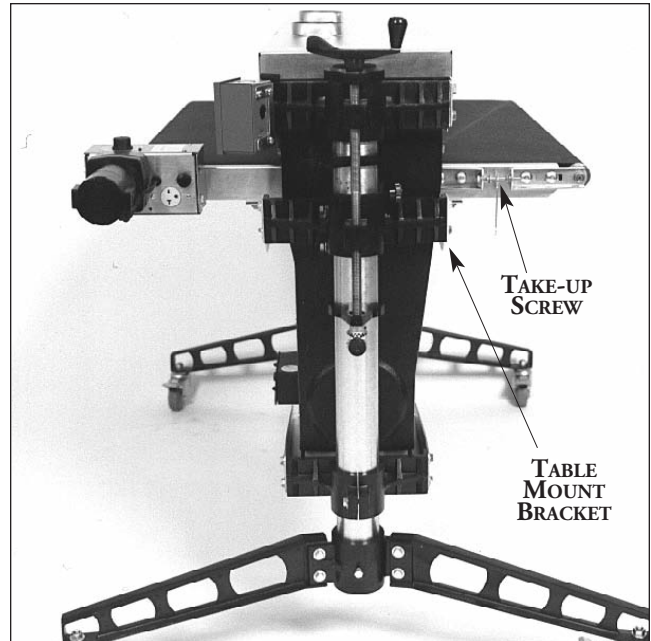

Fig. 35. Conveyor belt replacement.

Step 1. Check the conveyor drive and driven roller to make sure they are parallel to the surface of the conveyor bed. To do this, first center the conveyor belt on the bed. Then lay a straight-edge on the exposed edge of the conveyor table on the left (out-board) side, extending it over the drive roller, then driven roller. Note the distance between the drive roller then driven roller and the straight-edge.

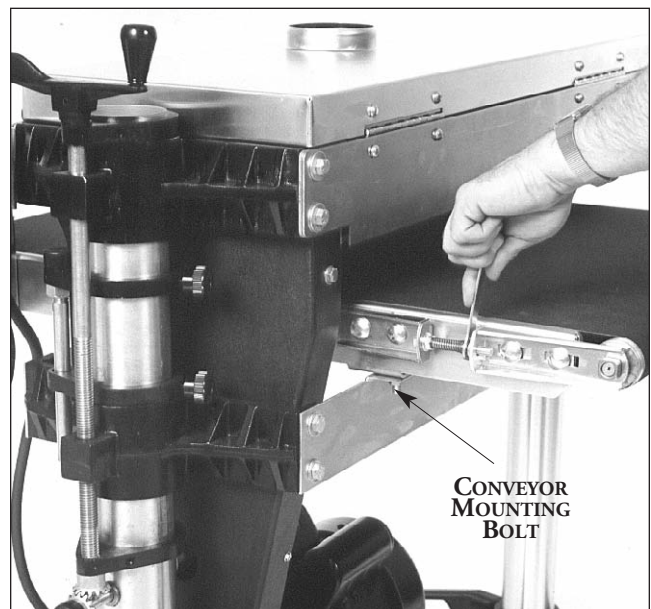

Fig. 36. Tensioning and tracking conveyor belt.

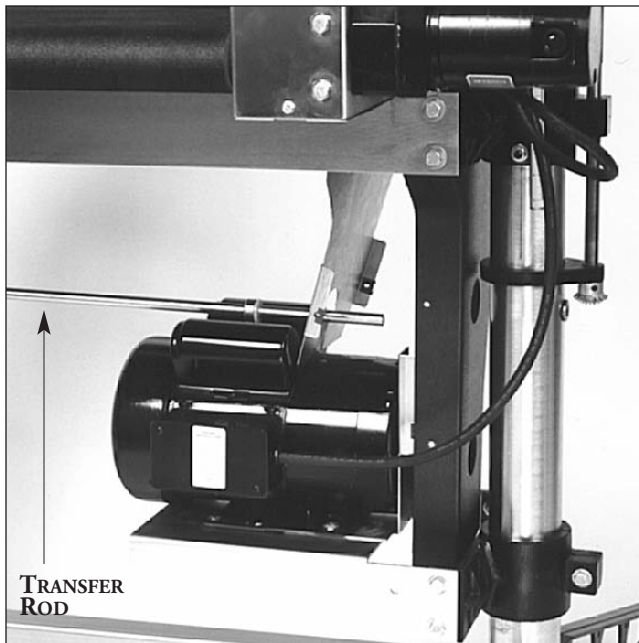

Fig. 37. Removing belt guard and transfer rod.

Step 2. Now repeat Step 1 on the right (inboard) side of the conveyor. Compare the measurements from side to side. If they are not equal, loosen one of the brackets that hold the drive or driven roller in place. Tip this bracket until the distance between the drive or driven roller and the straight-edge are equal from side to side, then tighten the bracket.

REPLACING V-BELT

To change the V-belt on the SUPERMAX, first unplug machine from the outlet. Remove two screws in lower section of belt guard and loosen the pinch bolt of the motor support casting. Raise the motor and retighten the pinch bolt. The procedure is the same for single drum sanders except that there is one driven pulley instead of two.

V-Belt Removal

1. Remove the lower outer belt cover by removing the four 10-32 screws holding it in place (see Fig. 29 and 37). Remove the two 5/16" x 1/2" hex head bolts holding it in place; pull the middle cover to the left. Take the V-belt off the pulley (Fig. 38).

2. Loosen the pinch bolt of the motor support casting, raise the motor, and re-tighten pinch bolt.

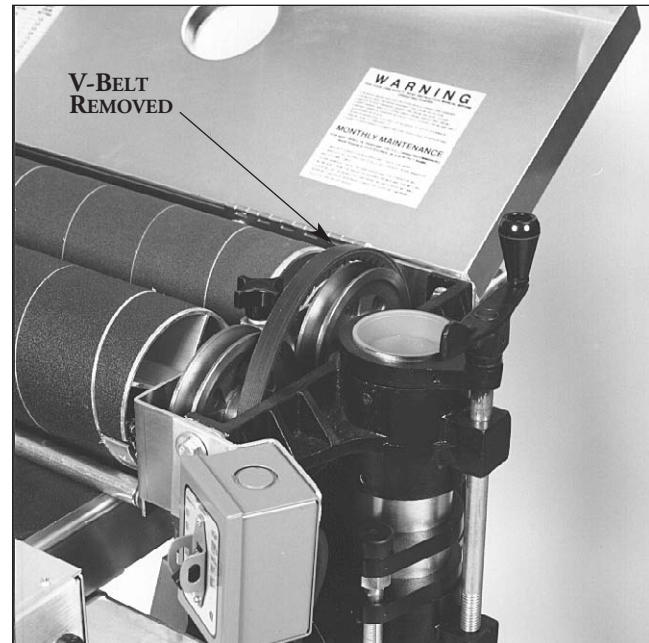

Fig. 38. Removing main motor V-belt drive.

3. Remove the miter gear from the right (inboard) side of the transfer rod. Loosen the shaft collar on the left (outboard) side of the rod, and pull the rod back enough so the V-belt can be removed. Note the routing of the old V-belt; now remove the old V-belt and replace it with the new V-belt.

Machine Reassembly

1. To reassemble the unit after replacing the V-belt, first place the transfer rod back through the machine. Tighten the shaft collar. Reinstall the miter gear on the transfer rod, making sure the set screw is centered on the flat of the rod.

2. Adjust the tension on the V-belt by sliding the motor down and then tightening the pinch bolt in the motor support casting. Adjust so the belt deflects about 1/2" between the pulleys when pressed. Excessive tension can increase motor load and decrease bearing life, while a loose belt can reduce operating efficiency and shorten belt life.

3. Reinstall the outer and middle belt guard using the two 5/16" x 1/2" hex head bolts and the four 10-32 screws.

4. Make sure that the pulleys are in alignment by holding a straightedge across their flat sides and adjusting to it. Also check that all bolts are tight before using the sander.

ROTATING/REPLACING DRUM BEARINGS

Replacing the permanently lubricated drum bearings on the SUPERMAX sander is a relatively straight-forward procedure. Bearings should be replaced when they allow excessive play of the drum, make excessive noise, or otherwise indicate failure.

Note that if clicking noises in the bearings are a problem, rotating may be a solution instead of replacement, as follows (See Fig. 40):

Rotating Bearings

Step 1. Loosen the set screws in the bearing collar. Leave the allen wrench in one of the set screws. Then rotate the drum within the bearing and tighten the set screws.

Step 2. If the clicking persists, or if the drum shaft is tight in the bearing and cannot rotate, then loosen the two bolts holding the bearing and the flange for the bearing. Now repeat Step 1. After the drum is rotated within the bearing, tighten the flanges first and then the set screws. **Note:** After tightening the rear bolt in the flange, loosen it approximately 1/4 turn, which allows the rear drum to pivot. After the machine has run for a half hour, stop to check that the set screws and bearing bolts are tight.

The general procedure outlined below suggests replacing bearings on the left (outboard) side, one at a time, starting with the rear drum of dual drum sanders, then moving to the front drum. Then, if needed, proceed to the right (inboard) side, also working on the rear drum of dual drum sanders first, then the front drum.

Disassembly Procedure

1. To begin the procedure in all cases, disconnect power to sander.
2. Remove the outer belt guard cover by removing the two 5/16" x 1/2" hex head bolts holding it in place, then the four 10-32 screws in the lower half. Slide the middle section back and the outer guard to the side.

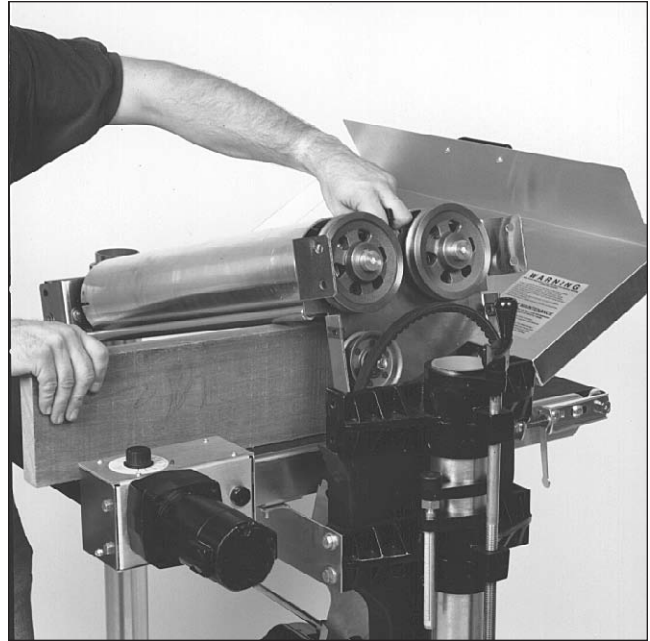

Fig. 39. Supporting drums to remove bearings.

3. Loosen the pinch bolt of the motor support casting and raise the motor to loosen the V-belt.

4. Next, level the drums to each other (see pages 7 and 8 in this manual). Then raise the conveyor bed until the drum(s) rest on the conveyor bed. With this done, follow the steps below:

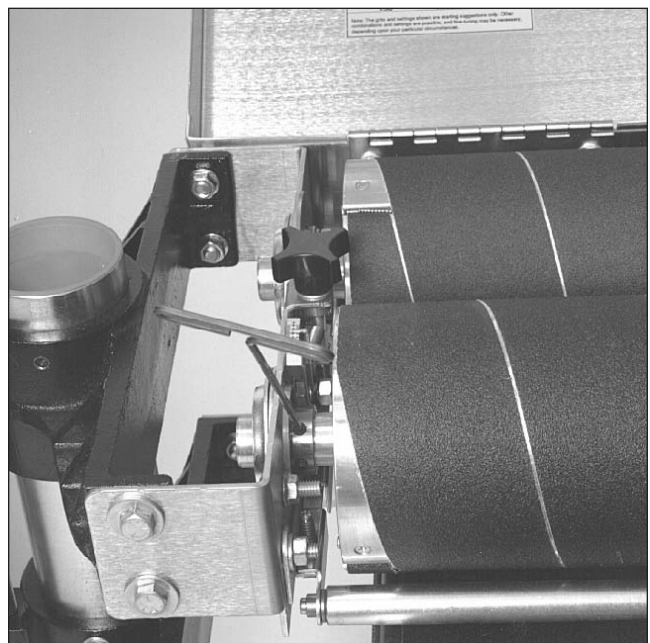

Fig. 40. Locating bearing set screws.

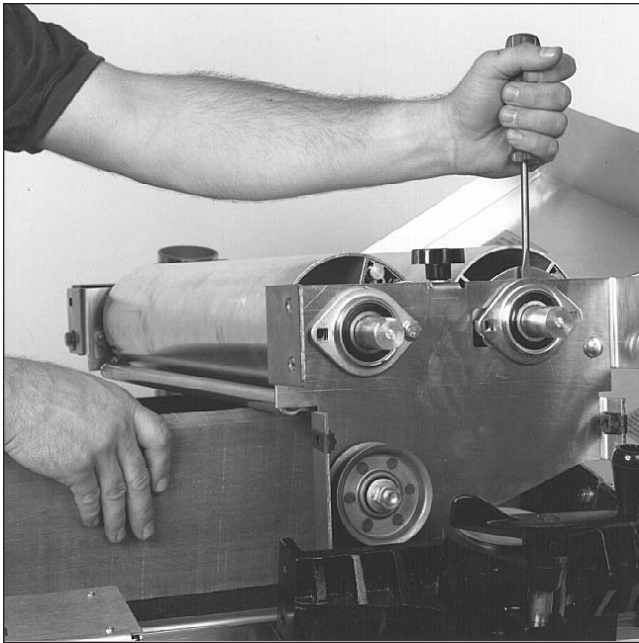

Fig. 41. Removing rear drum bearing.

Bearing Replacement (Left Side). If replacing all bearings, work first on the bearings on the left (or outboard) side of the sander first, one at a time, starting with the rear drum on dual drum sanders. (Follow Steps 1 through 3 for the bearing on the left side of single drum sanders, but do not loosen the rear bolt as instructed in Step 3.)

1. Begin by removing the outer half of the bearing flange. Loosen the set screws in the bearing collars and remove the bearing (Fig. 41).
2. If the shaft of the drum is rough from the set screws, use emery cloth or sandpaper to smooth down any raised edges. Slide the new bearing on the shaft, but do not tighten the set screws yet.
3. Install the outer half of the original bearing flange and tighten the bolts on the rear drum. After tightening the rear bolt in the flange, loosen it approximately 1/4 turn, which allows the rear drum to pivot. Then tighten the set screw in the bearing collar (Fig. 43).
4. Now move to the front drum and repeat Steps 1 through 3, but do not loosen the rear bolt as instructed in Step 3. **Important:** Be sure to note the sequence of parts used for the rear drum indicator assembly. Also, when reinstalling, do not

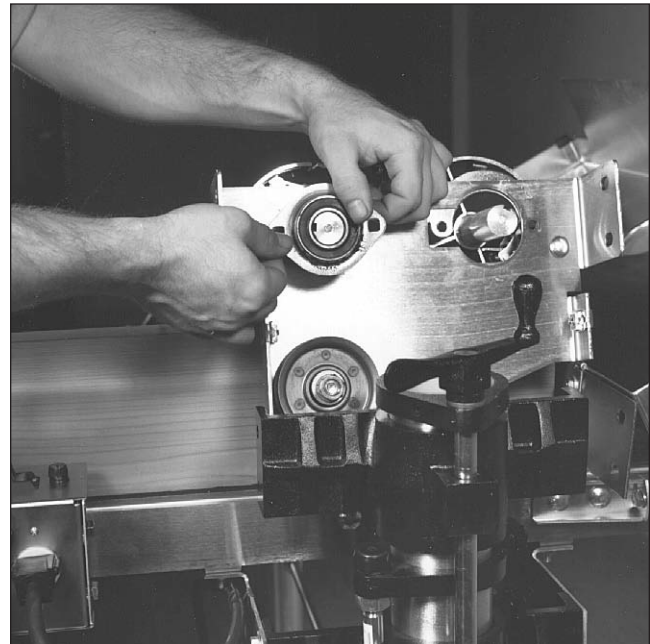

Fig. 42. Removing front bearing (inboard side).

over-tighten the nut that holds the indicator in place (see exploded view, page 43).

Bearing Replacement (Right Side). If the left (outboard) bearings are the only ones that need changing, proceed to reassemble the unit. You can check the drums at this point by lowering the conveyor bed and spinning the drums by hand. This will help determine if the inboard bearing(s) need to be changed to eliminate noise or excessive play in the drum.

1. With the drums resting on the conveyor bed, proceed as follows. Remove the four 3/8" x 1 1/4" bolts from the drum support casting on the right side, remove the on/off switch and depth gauge with the bolts.
2. Next, remove the upper two 3/8" x 1 1/4" bolts from the drum support casting on the left (outboard) side of the sander. Loosen the bottom two 3/8" x 1 1/4" bolts from the left drum support casting, but do not remove them.
3. Lift the right (inboard) side of drums and place a 2x6 on edge under the drums. Loosen and remove the V-belt pulleys from drum shafts (see Fig. 39). **Important:** Make sure to note the location of the pulleys. Also measure the distance from



Fig. 43. Removing rear bearing (inboard side).

pulley edge to the drum support casting to use as a reference when reinstalling pulleys so they will be properly aligned.

4. Replace bearings by following Steps 1 through 4 under **Bearing Replacement (Left Side)** above (Fig. 41-44).

5. Reinstall V-belt pulleys on the drum shafts, making sure they are located in the same position as before. Doublecheck this alignment after the drums have been bolted back in place, using the measurement from Step 3 above.

6. Lower the drums by removing the 2x6. Reinstall the six 3/8" x 1 1/4" bolts in the drum support castings and tighten them. Install the on/off switch and depth gauge with the two inboard bolts.

Reassembly Procedure

1. Lower the conveyor and spin the drums by hand to make sure the drum shaft is not binding in the bearing. If the bearings bind, loosen the set screws and the bearing flange for one bearing at a time. Spin the drum within the collar, then tighten the set screws and then the bearing flange (Fig. 40).

2. Next, check the alignment of the drums to the

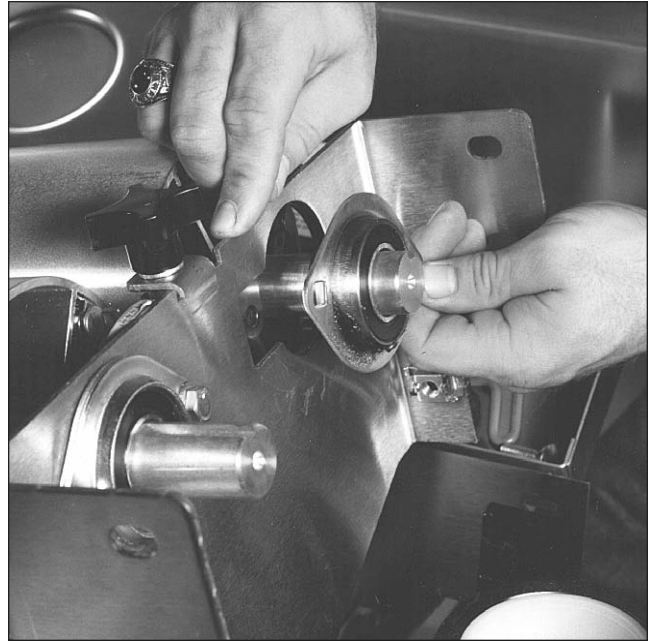

Fig. 44. Installing rear bearing (inboard side).

conveyor system. (For instructions on this procedure, see pages 7 and 8 of this manual.) Make sure the drums are parallel to each other.

3. Reinstall the V-belt on the motor pulley and adjust its tension. Then reinstall the pulley guard.

4. Test-run the sander before sanding stock to recheck that all is operating properly and is aligned before sanding good stock. Also, stop the sander after a couple hours of use and check the bolts and set screws to make sure they are seated properly.

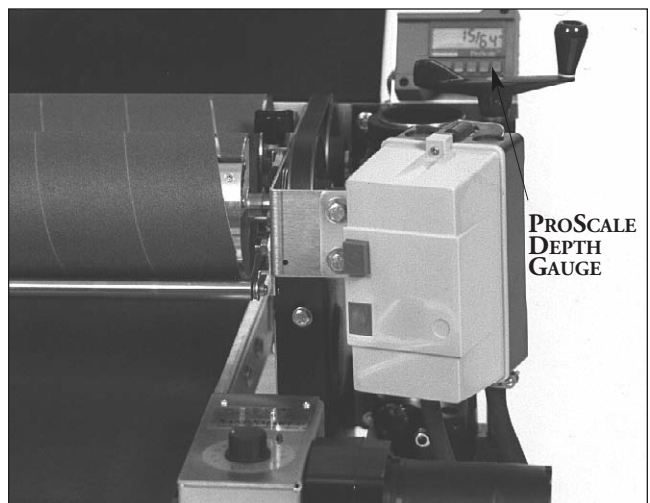

Fig. 45A. Conveyor control box, on/off switch and ProScale SUPERMAX SE.

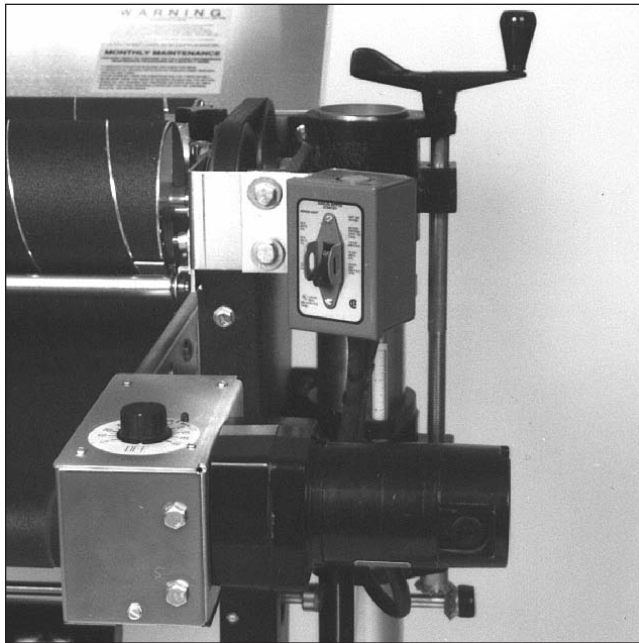

Fig. 45. Conveyor control box and on/off switch, SUPERMAX HD.

REPLACING ELECTRICAL COMPONENTS

To replace either the variable-speed Intellisand control, the on-off switch, or the conveyor motor, use the following disassembly procedure (Fig. 45 and 45A):

First disconnect the power supply to the

machine. Next, remove the bottom plate from the control box. Loosen the set screw in the shaft coupler, and then remove the four 5/16" bolts that hold the conveyor motor assembly in place (Fig. 45). Next, remove the assembly from the machine, then turn it upside down to disconnect the leads from the components to be removed.

To replace the Intellisand control: remove the knob by loosening screw and remove nut that was under knob. Turn housing over, and remove the nuts holding control board in place. Lift control board from housing. Install the new controller, referring to the correct electrical diagram and reverse the disassembly procedure.

To replace the on-off switch: remove the two screws holding cover in place. Pull switch from box. Disconnect wire leads from switch and remove cover plate from switch. Referring to the correct electrical diagram, reverse the disassembly procedure.

To replace the gear motor: disconnect the three wire leads from the controller. Disconnect the plastic grommet protecting the wires passing through the sheetmetal. Then remove the four set screws that hold the motor to the sheetmetal bracket. Remove the old motor and install the new motor. Referring to the correct electrical diagram, reverse the disassembly procedure.

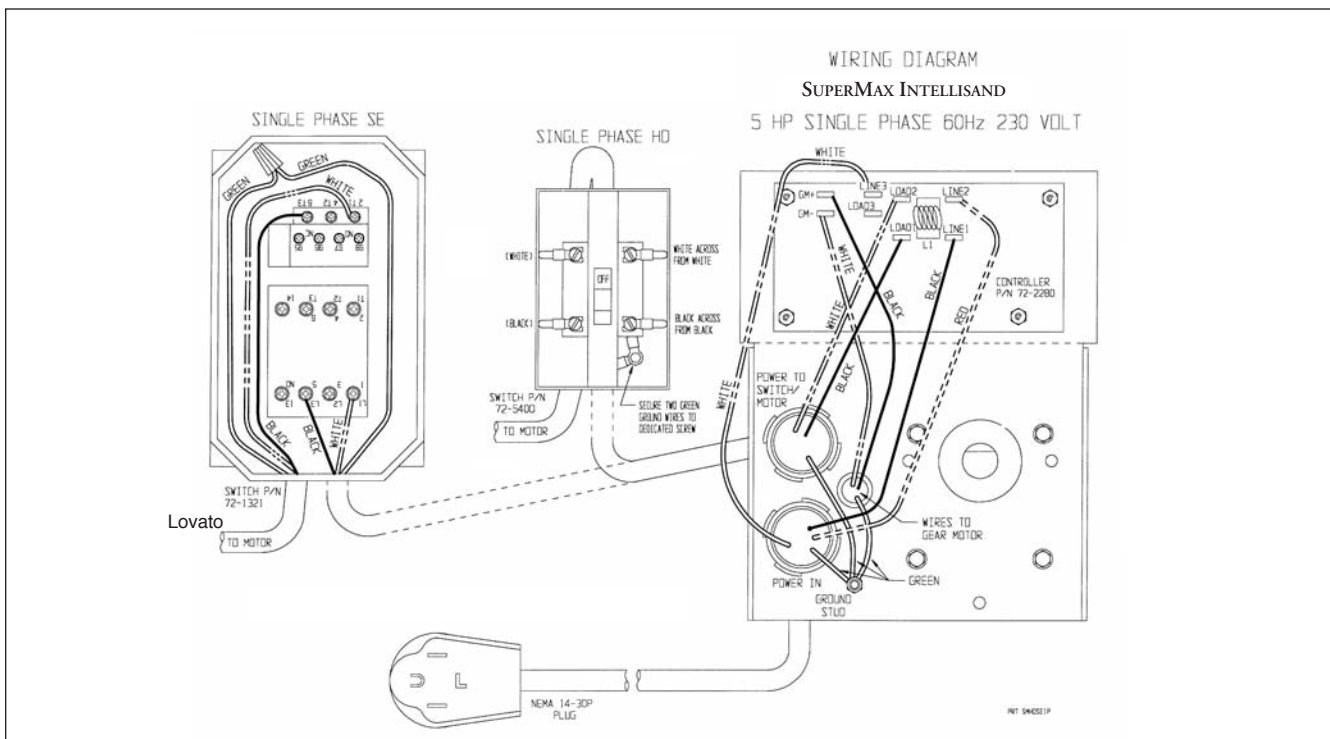

Single phase wiring diagram.

SUPERMAX SPECIFICATIONS

SUPERMAX 25 & 37 (single drum); SUPERMAX 25x2 & 37x2 (dual drum)

Dimensions:	Model 25 & 25x2: Height: 43 3/4"; Width: 46"; Depth: 31" Model 37x2: Height: 49"; Width: 58"; Depth 31"
Dust Hood:	Model 25 & 25x2: 4" vacuum port, hinged back. Model 37 & 37x2: Two 4" vacuum ports, hinged back.
Drums:	Model 25: 5" x 25"; Model 25x2: Two 5" x 25"; Model 37: 5" x 37"; Model 37 x 2: Two 5" x 37" All drums extruded aluminum, precision machined and balanced, 1,600 RPM.
Bearings:	All Models: 1" sealed, permanently lubricated, flanged ball bearings.
Abrasive Strips:	Tapered aluminum oxide or ceramic cloth-backed abrasive strips recommended. Fasteners accept any grit. No felt, velcro, or adhesive necessary. One strip included.
Conveyor Bed:	All Models: Steel conveyor bed reinforced with four steel cross sections.
Conveyor Motor:	All Models: 100 in-lbs. torque, direct-drive DC motor. Infinitely variable from 0 to 15 feet per minute with Intellisand.
Conveyor Belt:	All Models: 100-grit abrasive conveyor belt included.
Stand Construction:	All Models: Cast aluminum, zinc-plated steel. Column tubes are centerless ground.
Drive Motor:	All Models: 5 HP; TEFC; 1,740 RPM; 208-230 volts; 60 HZ.
Minimum Stock Length:	Models 25 & 37: 2 1/2"; Models 25x2 & 37x2: 3 1/2"
Height Adjustment:	All Models: 3/32" per turn; Depth Gauge included.
Stock Thickness Capacity:	25 and 25x2: 6"; 37 and 37x2: 12"
Shipping Weight:	Model 25: 350 lbs.; Model 25x2: 375 lbs.; Model 37: 400 lbs.; Model 37x2: 455 lbs.
Dust Collection:	Mandatory for all models.

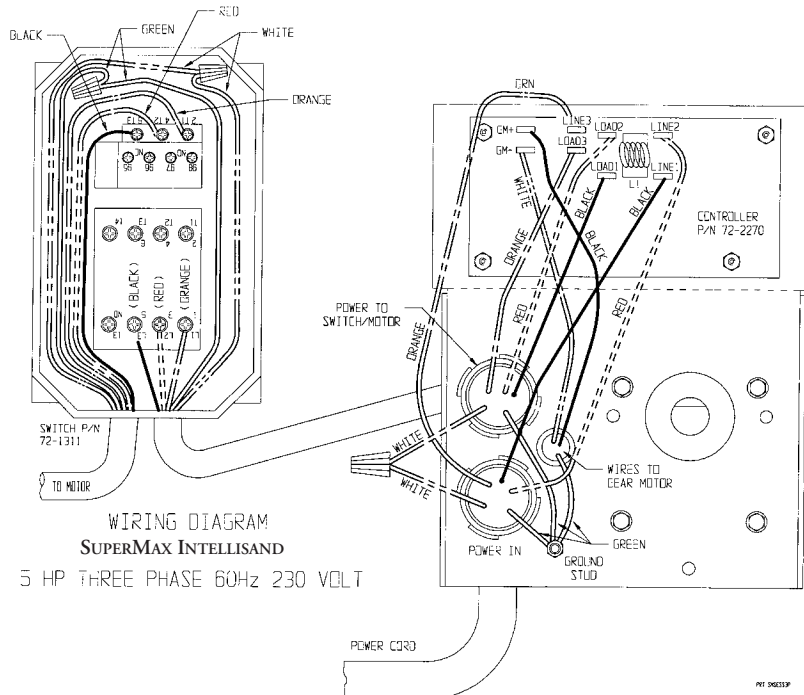

Three phase wiring diagram.

SUPERMAX STAND ASSEMBLY PARTS LIST

Ref. Number	Description	Part Number			Qty./Unit
		SM25x2	Both	SM37x2	
		Models			
1	HEIGHT ADJUSTMENT HANDLE ASSEMBLY		31-0020		1
2	3/16"x1" ROLL PIN		20-0772		1
3	5/8" I.D. OILITE WASHER		50-3080		2
4	3" PLASTIC COLUMN TUBE CAP		80-4015		2
5	ADJ. SCREW SUPPORT CASTING		30-1112		3
6	1/4"-20x1/2" SOCKET HEAD SET SCREW		10-2804		6
7	5/16"-18x3/8" SOCKET HEAD SET SCREW		10-2903		4
8	PLASTIC CAP		80-4013		3
9	SELF TAPPING SCREW		10-3905		2
10	DEPTH GAUGE POINTER	40-1102			1
11	DEPTH GAUGE SCALE	40-1101		94-1654	1
11	DEPTH GAUGE (NOT SHOWN)			30-1260HR	1
12	DRUM SUPPORT CASTING – SINGLE		30-5106		2
	– DUAL		30-5206		2
13	DEPTH LOCK CASTING		30-1112		2
14	INBOARD TABLE SUPPORT CASTING – SINGLE		30-5104		1
	– DUAL		30-5204		1
15	5/16"-18 HEX NUT		12-0003		4
16	5/16" SAE WASHER		11-0206		4
17	5/16"-18x3/4" BRASS TIPPED SET SCREW		10-9906		4
18	LOCKING KNOB		81-3132		2
19	OUTBOARD TABLE SUPPORT CASTING – SINGLE		30-5105		1
	– DUAL		30-5205		1
20	TABLE MOUNT BRACKET	40-0025		40-4242	2
21	3/8"-16x1" HEX HEAD BOLT		10-0205		18
22	5/16" WROUGHT WASHER		11-9103		37
23	3/8"-16 FLANGE LOCK NUT		12-0209		24
24	INBOARD HEIGHT ADJ. SCREW	30-1212		30-1212HR	1
25	MITER GEAR		20-1101		4
26	1/2" I.D. OILITE BUSHING		50-3107		4
27	COLUMN TUBE	30-1236			2
27	COLUMN TUBE			30-3044	2
28	1/2-13x1/2" SOCKET HEAD SET SCREW		10-8905		2
29	SHAFT COLLAR 1/2" I.D.		20-1103		2
30	TRANSFER ROD	30-1213		30-3117	1
31	MOTOR MOUNT		40-0106		1
32	MOTOR SUPPORT CASTING		30-5107		1
33	3/8"-16x1 1/2" HEX HEAD BOLT		10-9207		9
34	LEG CASTING	30-1102			4
34	LEG CASTING			30-1103	4
35	COLUMN BASE CASTING		30-1101		2
36	LEVELING FEET	20-0655			4
37	3/8"-16 HEX NUT		12-0005		8
38	BASE SUPPORT BRACKET	40-0230		40-4241	1
39	RETAINING RING		20-0752		1
40	OUTBOARD HEIGHT ADJ. SCREW	30-1211		30-1211HR	1

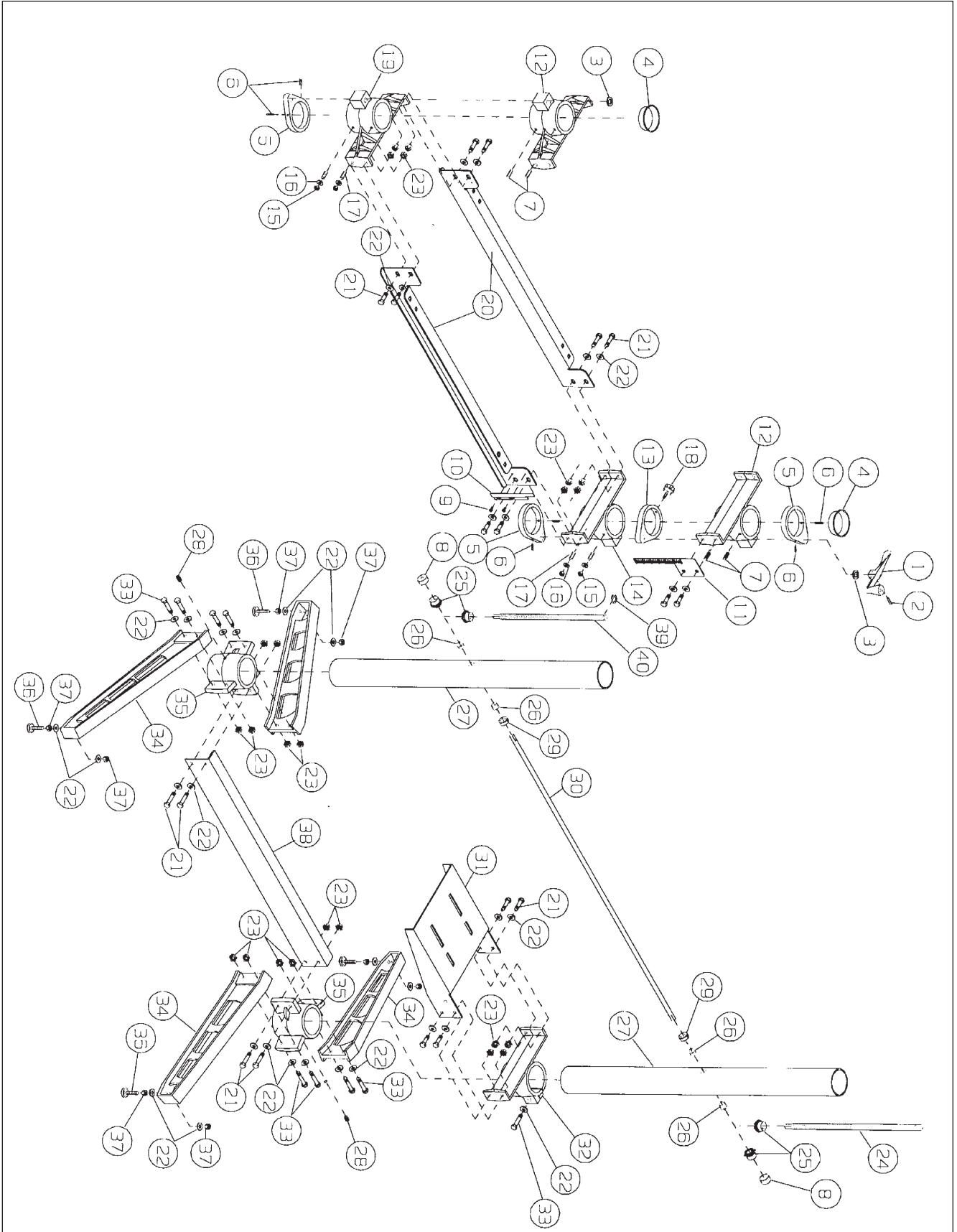

SUPERMAX SINGLE DRUM HEAD ASSEMBLY PARTS LIST

Ref. Number	Description	Part Number			Qty./ Unit
		SM25	Both Models	SM37	
1	DUST COVER	40-0525		40-4237	1
2	DUST COVER HANDLE		80-2841		1
3	#8x1/2" HEX HEAD SELF TAPPING SCREW		10-3904		2
4	1/4"-20x1/2" ROUND HEAD MACH SCREW		10-3205		8
5	1/4" INTERNAL TOOTH LOCK WASHER		11-0504		8
6	DUST COVER MOUNT	40-0240		40-4243	1
7	HINGE		40-0225		2
8	1/4" SAE WASHER		11-0205		8
9	1/4"-20 HEX NUT		12-0001		8
10	3/8"-16x1" HEX HEAD BOLT		10-9205		8
11	5/16" WROUGHT WASHER		11-9103		8
12	DRUM MOUNTING BRACKET		40-0210		2
13	3/8"-16 FLANGED LOCK NUT		12-0209		8
14	5/16"-18x1" CARRIAGE HEAD BOLT		10-1204		4
15	DRUM BEARING		50-3057		2
16	1/4"-28x1/4" SET SCREW (BEARING)		10-8602		4
17	#8-32x1" PHILLIPS FILLISTER HEAD SCREW		10-3107		4
18	COMPRESSION SPRING		20-3268		4
19	RIGHT TENSION ROLLER SUSPENSION BKT.		40-0302		2
20	LEFT TENSION ROLLER SUSPENSION BKT.		40-0303		2
21	TENSION ROLLER BASE BKT.		40-0304		2
22	#8-32 SQUARE NUT		12-0102		4
23	5/16" SAE WASHER		11-0206		4
24	5/16"-18 HEX NUT		12-0003		4
25	5/16"-I.D. OILITE BUSHING		50-3105		4
26	TENSION ROLLER	30-1205		30-3119	2
27	OUTBOARD ABRASIVE FASTENER		21-1173		1
28	#6-32x3/8" FLAT HEAD PHILLIPS SCREW		10-3003		2
29	SANDING DRUM	30-1200		30-3100	1
30	INBOARD ABRASIVE TAKEUP FASTENER		21-1172		1
31	1/4"x1" KEY STOCK		20-0762		1
32	UPPER INNER BELT GUARD		40-3050		1
33	#10-24 RETAINING NUT		20-1155		4
34	DRIVEN PULLEY		50-0502		1
35	5/16"-18x3/8" SET SCREW (PULLEY)		10-8903		1
36	MIDDLE INNER BELT GUARD		40-3061		1
37	BELT GUARD COVER		40-3060		1
38	#10-24x3/8" SLOTTED HEX HEAD SCREW		10-3803		4

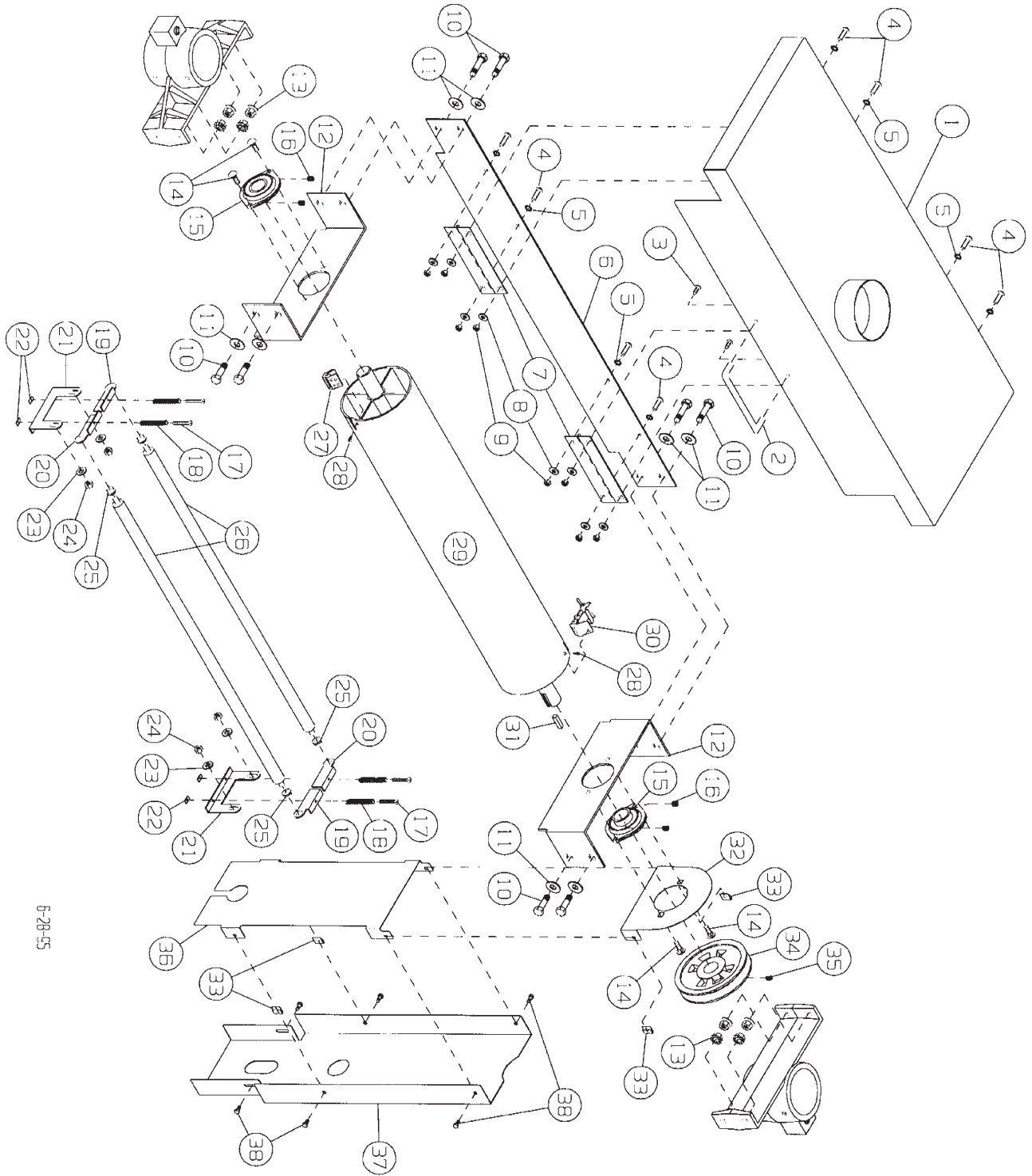

SUPERMAX DUAL DRUM HEAD ASSEMBLY PARTS LIST

Ref. Number	Description	Part Number			Qty./ Unit
		SM25x2	Both Models	SM37x2	
1	DUST COVER	40-1525		40-3237	1
2	DUST COVER HANDLE		80-2841		1
3	#8x1/2" SELF TAPPING SCREW		10-3904		2
4	1/4"-20x1/2" ROUND HEAD MACH SCREW		10-3205		8
5	1/4" INTERNAL TOOTH LOCK WASHER		11-0504		8
6	DUST COVER MOUNT	40-0240		40-4243	1
7	HINGE		40-0225		2
8	1/4" SAE WASHER		11-0205		8
9	1/4"-20 HEX NUT		12-0001		8
10	3/8"-16 x1" HEX HEAD BOLTS		10-9205		8
11	5/16" WROUGHT WASHER		11-9103		8
12	3/8"-16 FLANGED LOCK NUT		12-0209		8
13	1/4"-28x1/4" SOCKET HEAD SET SCREW (BEARING)		10-8602		8
14	5/16"-18x1" CARRIAGE HEAD BOLT		10-1204		6
15	5/16"-18x1 1/4" HEX HEAD BOLT		10-9106		2
16	5/16" SAE WASHER		11-0206		10
17	5/16" I.D. SPACER		30-1305		2
18	DRUM BEARING		50-3067		4
19	OUTBOARD DRUM MOUNT BKT.		40-0519		1
20	5/16"-18 HEX NUT		12-0003		8
21	SECONDARY DRUM ADJ. KNOB		80-3135		2
22	5/16" I.D. SHAFT COLLAR WITH SET SCREW		20-1102		2
23	OUTBOARD SECONDARY DRUM ADJ. BKT.		40-0527		1
24	5/16" LOCK WASHER		11-0010		2
25	OUTBOARD SECONDARY DRUM INDICATOR		95-1659		1
26	BRASS SPACER		30-1303		2
27	3/8" SPRING WASHER		20-1165		2
28	EXTENSION SPRING		20-3210		2
29	1/4" x 1" KEY STOCK		20-0762		2
30	OUTBOARD INDICATOR NEEDLE		40-0531		1
31	OUTBOARD ABRASIVE FASTENER		21-1173		2
32	#6-32x3/8" FLAT HEAD PHILLIPS SCREW		10-3003		4
33	SANDING DRUM	30-1200		30-3100	2
34	INBOARD ABRASIVE TAKEUP FASTENER		21-1172		2
35	INBOARD INDICATOR NEEDLE		40-0530		1
36	INBOARD SECONDARY DRUM INDICATOR		95-1660		1
37	INBOARD SECONDARY DRUM ADJ. BKT.		40-0526		1
38	1/2"-13x2" HEX HEAD BOLT		10-0407		1
39	1/2" INTERNAL TOOTH LOCK WASHER		11-0508		1
40	INBOARD DRUM MOUNT BKT.		40-0520		1
41	5/16"-18 RETAINING NUT		20-1159		2
42	1/2" I.D. SPACER		30-1304		1
43	IDLER PULLEY		50-1258		1
44	1/2" SAE WASHER		11-0209		1
45	1/2" LOCK WASHER		11-0013		1

(Continued on page 44)

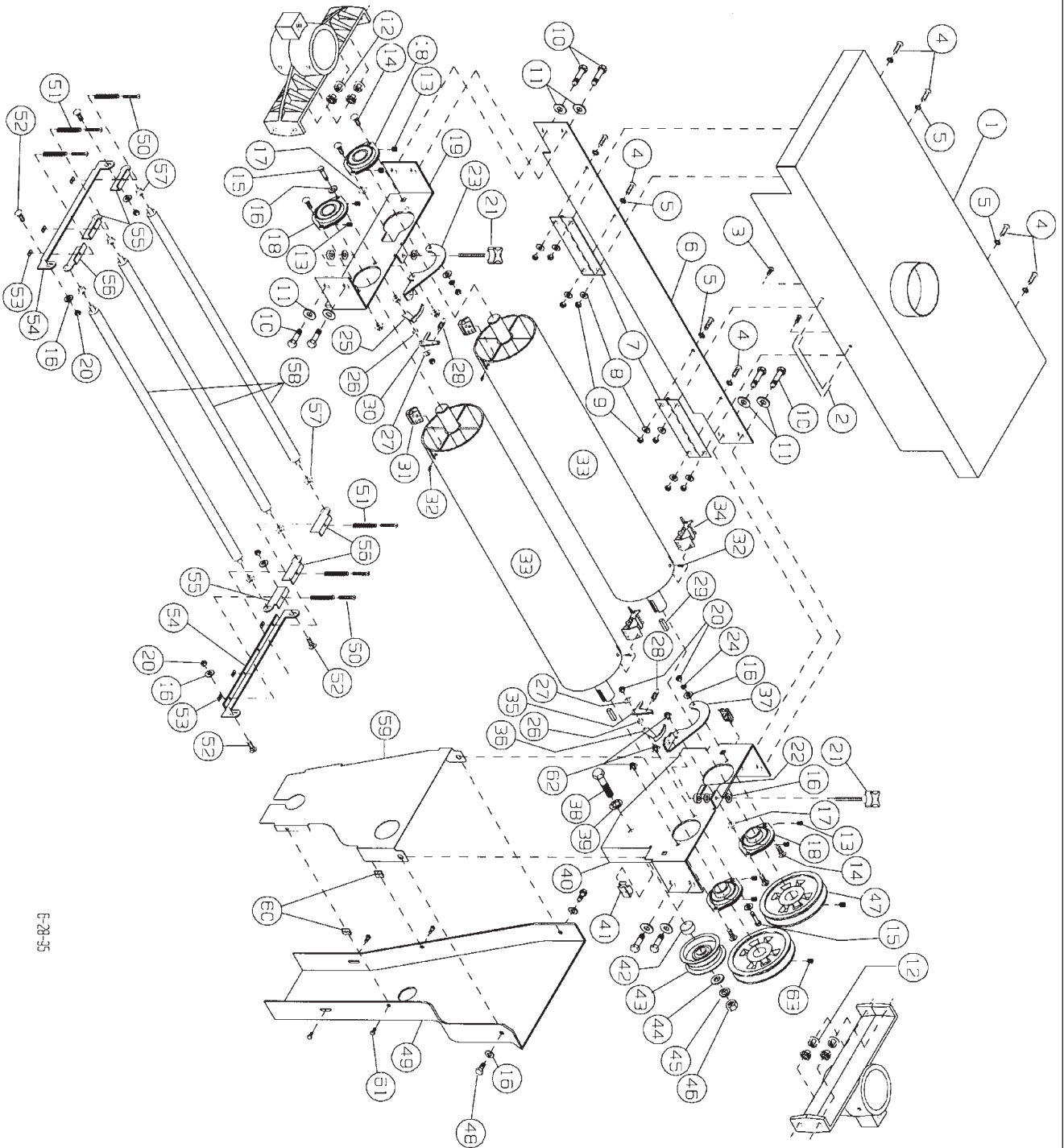

E-28-35

SUPERMAX DUAL DRUM HEAD ASSEMBLY PARTS LIST (Cont'd)

Ref. Number	Description	Part Number			Qty./ Unit
		SM25x2	Both Models	SM37x2	
46	1/2"-13 HEX NUT		12-0009		1
47	DRIVEN PULLEY		50-0502		2
48	5/16"-18x1/2" HEX HEAD BOLT		10-9101		2
49	BELT GUARD COVER	80-1028		80-1038	1
50	#8-32x1" PHILLIPS FILLISTER HEAD SCREW		10-3107		6
51	COMPRESSION SPRING		20-3268		6
52	5/16"-18x3/4" CARRIAGE HEAD BOLT		10-1203		4
53	#8-32 SQUARE NUT		12-0102		6
54	TENSION ROLLER BASE BKT.		40-0306		2
55	TENSION ROLLER SUSPENSION BKT., RIGHT		40-0302		3
56	TENSION ROLLER SUSPENSION BKT., LEFT		40-0303		3
57	5/16" I.D. OILITE BUSHING		50-3105		6
58	TENSION ROLLER	30-1205		30-3119	3
59	MIDDLE INNER BELT GUARD		41-1028		1
60	#10-24 RETAINING NUT		20-1155		2
61	#10-24x3/8" SLOTTED HEX HEAD SCREW		10-3803		4
62	5/16"-18 FLANGED LOCK NUT		12-0207		6
63	5/16"-18x3/8" SET SCREW (PULLEY)		10-8903		2
64	BELT GUARD PLATE (NOT SHOWN)		41-1010		1

SUPERMAX CONVEYOR & MOTOR PARTS LIST

Ref. Number	Description	Part Number			Qty./ Unit
		SM25	Both Models	SM37	
1	DRIVEN ROLLER	30-3103		30-3104	1
2	1/2" I.D. SQUARE OILITE BUSHING		50-3109		4
3	TAKEUP SLIDE		40-4108		2
4	5/16" SAE WASHER		11-0206		2
5	5/16"-24 FLANGED NUT		12-0308		6
6	WRENCH		40-0375		2
8	TAKEUP BASE BRACKET		40-4107		2
9	3/8"-16x1" CARRIAGE BOLT		10-1302		16
10	5/16"-24x3" STUD		30-1306		2
11	3/8"-16 NYLON INSERT LOCK NUT		12-8005		4
12	3/8" SPRING WASHER		20-1165		8
13	SIDE RAIL		40-4105		1
14	ROLLER SUPPORT BRACKET		40-4109		1
15	RUBBER COVERED DRIVE ROLLER	30-3106		30-3107	1
16	3/8"-16x3/4" CARRIAGE BOLT		10-1301		4
17	3/8" FLANGED LOCK NUT		12-0209		16
18	CONVEYOR BED	40-4101		40-4201	1
19	SIDE RAIL		40-4106		1

(Continued on page 46)

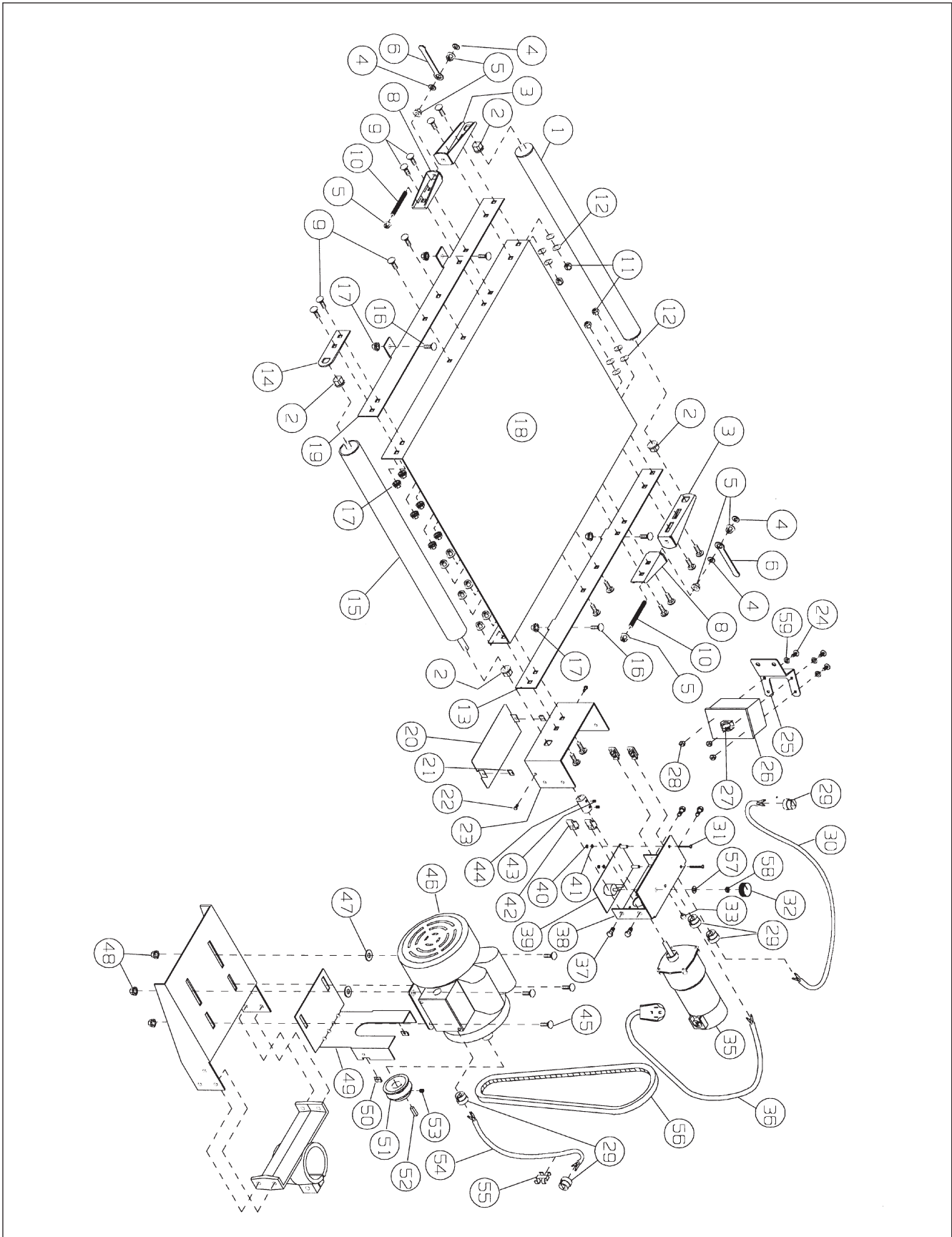

SUPERMAX CONVEYOR & MOTOR PARTS LIST (Cont'd.)

Ref. Number	Description	Part Number			Qty./ Unit
		SM25	Both Models	SM37	
20	BOTTOM COVER		40-4116		1
21	#10-24 RETAINING NUT		20-1155		2
22	#10-24x3/8" SLOTTED HEX HEAD SCREW		10-3803		2
23	CONTROL BOX BASE BRACKET		40-4115		1
24	1/4"-20x1/2" ROUND HEAD MACH SCREW		10-3205		3
25	SWITCH BRACKET, SINGLE PHASE		40-5005		1
25	SWITCH BRACKET, THREE PHASE		40-0124		1
26	SWITCH BOX		72-5400-2		1
27	ON/OFF SWITCH (DRUM), SINGLE PHASE		72-5400-1		1
27	ON/OFF SWITCH (DRUM), THREE PHASE		72-1311		1
28	1/4"-20 HEX NUT		12-0001		3
29	LARGE STRAIN RELIEF		72-1404		5
30	CORD SET, SINGLE PHASE		72-5315		1
30	CORD SET, THREE PHASE		72-5305		1
31	#6-32x1-1/4" PHILLIPS PAN HEAD SCREW		10-3902		2
32	KNOB		72-1270-1		1
33	SMALL STRAIN RELIEF		72-6102		1
35	180-VOLT GEAR MOTOR		71-1171		1
36	MAIN CORD SET, SINGLE PHASE		72-5430		1
36	MAIN CORD SET, THREE PHASE		72-5305		1
37	5/16"-18x1/2" HEX HEAD BOLT		10-9101		4
38	CONTROL HOUSING		40-5013		1
39	INTELLISAND CONTROLLER, SINGLE PHASE		72-2280		1
39	INTELLISAND CONTROLLER, THREE PHASE		72-2270		1
40	#6-32 NUT		12-9001		2
41	#6 WASHER		11-0202		2
42	5/16"-18 RETAINING NUT		20-1159		4
43	1/4"-20x1/4" SOCKET HEAD SET SCREW		10-8802		2
44	COUPLING (CONVEYOR)		30-3102		1
45	5/16"-18x3/4" CARRIAGE BOLT		10-1203		4
46	5 H.P. TEFC ELECTRIC MOTOR, SINGLE PHASE		70-0507		1
46	5 H.P. TEFC ELECTRIC MOTOR, THREE PHASE		70-1503		1
47	3/8" WROUGHT WASHER		11-0104		2
48	5/16"-18 FLANGED LOCK NUT		12-0207		4
49	LOWER INNER BELT GUARD		40-1000		1
50	#10-24 RETAINING NUT		20-1157		2
51	4 1/2" DRIVE PULLEY		50-0450		1
52	1/4"x1" KEY STOCK		20-0762		1
53	5/16"-18x3/8" SOCKET HEAD SET SCREW		10-8903		1
54	CORD SECTION, SINGLE PHASE		72-5315		1
54	CORD SECTION, THREE PHASE		72-5305		1
55	RETAINING CLIP		72-6210		1
56	V-BELT- SINGLE DRUM, 25"		50-2021		1
	- DUAL DRUM, 25"		50-2023		1
56	V-BELT- DUAL DRUM, 37"		50-2030		1
57	5/16" I.D. THIN WASHER		72-1270-3		1
58	5/16"-32 JAM NUT		72-1270-4		1
59	CONVEYOR BELT (NOT SHOWN)	60-0324		60-0337	1

SUPERMAX ACCESSORY & SUPPLY CHECKLIST

ITEM #	DESCRIPTION	QTY.
---------------	--------------------	-------------

SUPERMAX OPTIONS

98-0130	CASTER SET: Heavy duty, roll & swivel lock. (Set of 4)	
98-0070	RACK-N-ROLL: Abrasive storage system.	

ABRASIVES

Resin bond, non-adhesive abrasive cloth strips.

- Pre-Marked, 60 grit and finer covers 25" drum 12 times, 37" drum 8 times
- Pre-Marked, 36 grit covers 25" drum 9 times, 37" drum 6 times
- Pre-Cut, grit includes 3 strips for 25" drum, 2 strips for 37" drum

Pre-Cut		Pre-Marked	Size and Description	
25"	37"			
60-5024	60-7024		24 GRIT: Surface rough sawn boards, stock & glue removal	
60-5036	60-7036	60-9036	36 GRIT: Surface rough sawn boards, stock & glue removal.	
60-5060	60-7060	60-9060	60 GRIT: Surfacing and dimensioning boards, trueing warped boards.	
60-5080	60-7080	60-9080	80 GRIT: Surfacing, light dimensioning, remove planer ripples.	
60-5100	60-7100	60-9100	100 GRIT: Light surfacing, remove planer ripples.	
60-5120	60-7120	60-9120	120 GRIT: Light surfacing, minimal stock removal.	
60-5150	60-7150	60-9150	150 GRIT: Finish sanding, minimal stock removal.	
60-5180	60-7180	60-9180	180 GRIT: Finish sanding, not for stock removal.	
60-5220	60-7220	60-9220	220 GRIT: Finish sanding, not for stock removal.	
60-5000	n/a	n/a	Assortment: 1 strip each of 36, 80, 120 grit.	
	60-0505		ABRASIVE CLEANING STICK	

Specialty abrasives are also available.

SUPERMAX POWER FEED CONVEYOR BELTS

TYPE 1: 100 grit abrasive surface with reinforced film backing.

TYPE 2: Polyurethane roughtop surface with monofilament backing.

TYPE 1	TYPE 2		
60-0324	61-1004	24" Power Feed Bed with 2" diameter Drive Roller.	
60-0337	61-1007	36" Power Feed Bed with 2" diameter Drive Roller.	

Note: It is our policy to not sell direct in an area that is served by a SuperMax Tools dealer. For information on the dealer nearest you, call 651-454-3401 or email sales@supermaxtools.com or visit our website at www.supermaxtools.com

DEALER NEAREST YOU:

2 YEAR WARRANTY

Limited warranty. We will provide replacement parts which are found to be defective in materials or workmanship.

CAUTION: IMPORTANT SAFETY INFORMATION

FOR SAFE SANDING OPERATION, FOLLOW THESE GUIDELINES:

- **BECOME FAMILIAR WITH THE PROPER OPERATIONAL PROCEDURES FOR USING THIS MACHINE.**
- **ALWAYS BE SAFETY CONSCIOUS WHEN OPERATING THE MACHINE.**
- **ALWAYS WEAR EYE PROTECTION WHILE OPERATING THE SANDER.**
- **ALWAYS FEED STOCK AGAINST THE ROTATION OF THE DRUM(S).**
- **NEVER PLACE HANDS UNDER THE DRUM(S) OR DUST COVER.**
- **NEVER OPERATE SANDER WITHOUT ITS DUST COVER OR DRUM AND BELT GUARDING IN PLACE.**
- **KEEP HANDS AND CLOTHING AWAY FROM OPERATING DRUM(S), BELT AND PULLEYS.**
- **ALWAYS MAINTAIN CONTROL OF STOCK TO AVOID KICKBACK; KNOW HOW TO PREVENT IT.**
- **ALWAYS DISCONNECT ELECTRICAL POWER BEFORE PERFORMING ANY SERVICING OR ADJUSTMENT OF THE MACHINE.**
- **DO NOT MODIFY THIS MACHINE: MODIFICATIONS ARE DONE AT THE OWNER'S RISK AND ALSO WILL VOID THE MANUFACTURER'S WARRANTY.**
- **FOR CUSTOMER SERVICE AND QUESTIONS ABOUT THE OPERATION OR MAINTENANCE OF THIS MACHINE, PLEASE CALL YOUR AUTHORIZED PERFORMAX DEALERSHIP.**